



LED WATERPROOF ESSENCE TW

KEY FEATURES

- Professional IP65 Waterproof fixture with modern design
- Lifetime of 50,000 hours
- Premium Osram LED Driver
- 3x1.5mm² and fast connectors at 2 ends for a quick (toolless) installation
- Replaces fixtures with TL tubes
- Up to 140 lumen per watt
- Payback time 1 to 2 years
- 5-year Pragmalux Warranty

APPLICATIONS

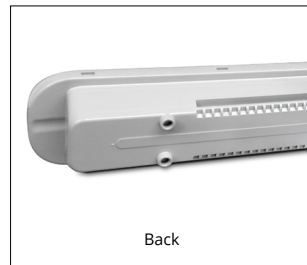

OPTIONS



SPECIFICATIONS

Item code	Description	W	Im	lm/W	Kelvin	CRI	Input current	Lifetime L80B10	Equivalent	Beam angle
4600505	LED Waterproof Essence IP65 24W 600 4000K Incl. 3x1.5mm TW	24	2,880	120	4,000	≥80	0.11A	50,000	2x18W FL	120°
4600499	LED Waterproof Essence IP65 20W 1200 4000K Incl. 3x1.5mm TW	20	2,600	130	4,000	≥80	0.10A	50,000	1x36W FL	120°
4600482	LED Waterproof Essence IP65 36W 1200 4000K Incl. 3x1.5mm TW	36	5,040	140	4,000	≥80	0.17A	50,000	1x58W FL	120°
4600475	LED Waterproof Essence IP65 30W 1500 4000K Incl. 3x1.5mm TW	30	3,700	123	4,000	≥80	0.14A	50,000	2x36W FL	120°
4600468	LED Waterproof Essence IP65 50W 1500 4000K Incl. 3x1.5mm TW	50	7,000	140	4,000	≥80	0.23A	50,000	2x58W FL	120°

TECHNICAL DATA

Electrical data	
Voltage (V)	220-240
Frequency (Hz)	50/60
Power factor (λ)	≥0.95
Operating mode	Integrated LED Driver
Electrical connection	Max 3x1,5 mm ² wire
Total harmonic distortion	≤ 20 %

Certificates & standards	
Driver certificates	CE/ENEC
Fixture certificates	CE/ENEC
Ingress protection	IP65
Protection class	II
Protection class IK	08
Glow Wire Test (IEC 695-2-1)	850°C
Photobiological safety group EN62778	RG0

Temperatures & operating conditions

Ambient temperature	25°C
Operating temperature	-25 ~ +35°C
Storage temperature	-25 ~ +80°C

Colors & materials

Color (Housing)	Grey RAL7035
Material (Housing)	PC
Material (Diffuser)	PC

Capabilities

UGR	≤25
Dimmable	No
Type of connection	Push Terminal, 3-pole
LED Module replacable	No
Installation	Through-wiring Possible

SPECIFICATIONS DRIVERS

Item code	Description	Driver failure rate at 5,000h	Inrush current Ipeak	Inrush current Twidth	Max. No. of drivers on MCB Type B 10A	Max. No. of drivers on MCB Type B 16A	Max No. of drivers on MCB Type C 10A	Max. No. of drivers on MCB Type C 16A
4600505	LED Waterproof Essence IP65 24W 600 4000K Incl. 3x1.5mm TW	≤1%	18A	100μs	30	48	30	48
4600499	LED Waterproof Essence IP65 20W 1200 4000K Incl. 3x1.5mm TW	≤1%	8.6A	126μs	40	70	70	116
4600482	LED Waterproof Essence IP65 36W 1200 4000K Incl. 3x1.5mm TW	≤1%	18A	100μs	30	48	30	48
4600475	LED Waterproof Essence IP65 30W 1500 4000K Incl. 3x1.5mm TW	≤1%	18A	100μs	30	48	30	48
4600468	LED Waterproof Essence IP65 50W 1500 4000K Incl. 3x1.5mm TW	≤1%	18A	100μs	25	40	25	40

DIMENSIONS

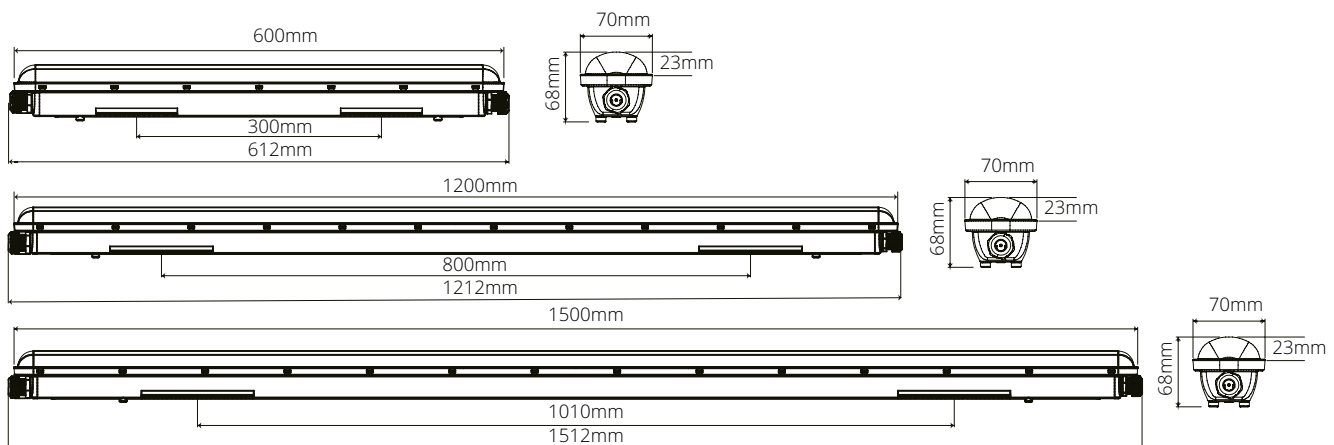

PRAGMALUX

All rights reserved. Pragmalux - PDL Lighting Group B.V. retains the right to modify product specifications without any prior notice or obligation and does not assume any liability for any consequences of using this document. Subject to errors and printing errors. Luminous flux tolerance: +/- 10%. Power consumption tolerance: +/- 10%.

Version: August 2019

ACCESSORIES

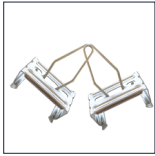

Triangle hook

PHOTOMETRIC SPECIFICATIONS

LED Waterproof Essence IP65 24W 600 4000K

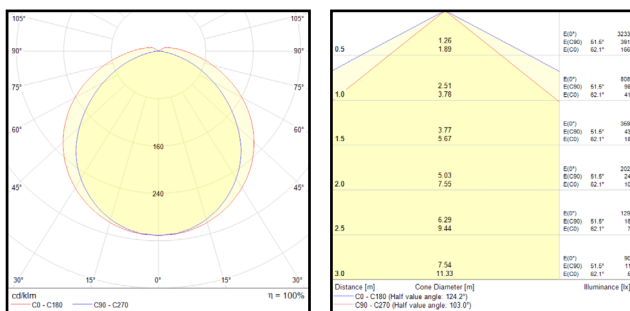

LED Waterproof Essence IP65 20W 1200 4000K

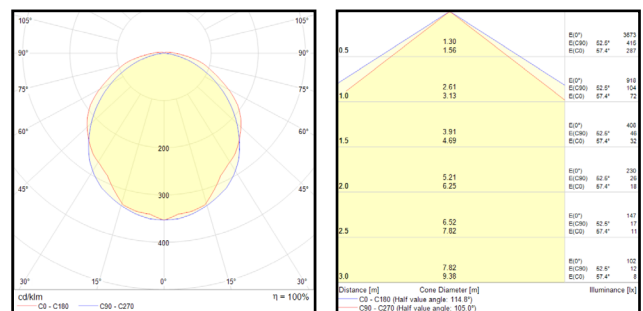

LED Waterproof Essence IP65 36W 1200 4000K

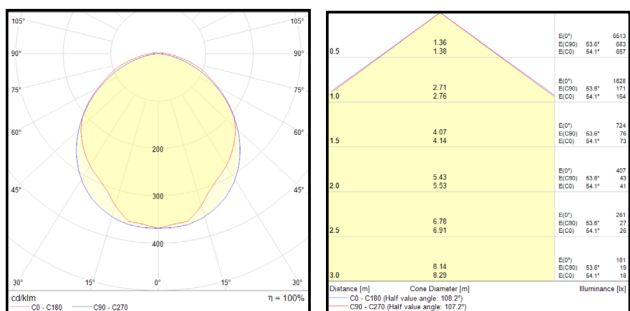

LED Waterproof Essence IP65 30W 1500 4000K

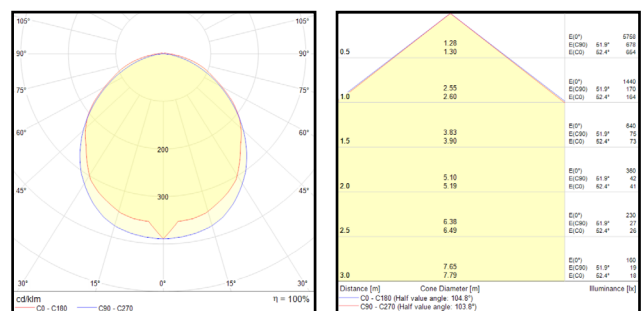

LED Waterproof Essence IP65 50W 1500 4000K

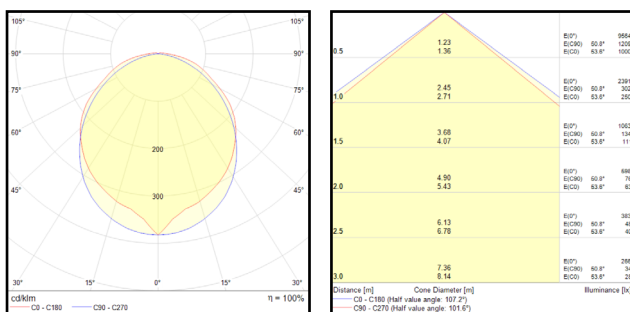

PRAGMALUX

All rights reserved. Pragmalux - PDL Lighting Group B.V. retains the right to modify product specifications without any prior notice or obligation and does not assume any liability for any consequences of using this document. Subject to errors and printing errors. Luminous flux tolerance: +/- 10%. Power consumption tolerance: +/- 10%.

Version: August 2019

LED WATERPROOF ESSENCE TW

PACKAGING INFORMATION

Item code	Description	Single box		Master carton		
		Dimensions(LxWxH) (mm)	Weight(kg)	Units per master carton	Dimensions(LxWxH) (mm)	Weight(kg)
4600505	LED Waterproof Essence IP65 24W 600 4000K Incl. 3x1.5mm TW	630x77x77	0.78	9	645x325x250	9.92
4600499	LED Waterproof Essence IP65 20W 1200 4000K Incl. 3x1.5mm TW	1230x77x77	1.18	9	1245x250x250	11.4
4600482	LED Waterproof Essence IP65 36W 1200 4000K Incl. 3x1.5mm TW	1230x77x77	1.18	9	1245x250x250	11.4
4600475	LED Waterproof Essence IP65 30W 1500 4000K Incl. 3x1.5mm TW	1530x77x77	1.4	9	1545x250x250	13.44
4600468	LED Waterproof Essence IP65 50W 1500 4000K Incl. 3x1.5mm TW	1530x77x77	1.4	9	1545x250x250	13.44

APPLICATIONS

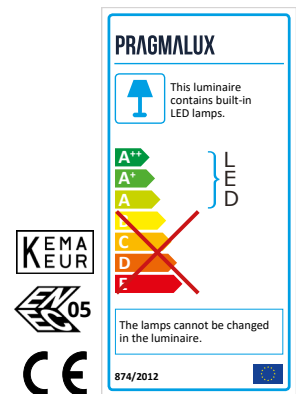

PRAGMALUX

All rights reserved. Pragmalux - PDL Lighting Group B.V. retains the right to modify product specifications without any prior notice or obligation and does not assume any liability for any consequences of using this document. Subject to errors and printing errors. Luminous flux tolerance: +/- 10%. Power consumption tolerance: +/- 10%.

Version: August 2019