

AGILA

2478PJP125P50

EAN 4031582030389

Faste hjul, Gaffel af stål, zink-kromatiseret, Hjul boltet i gaffel, Pladebefæstigelse.

Befæstigelsespladens længste side vender på tværs af kørselsretningen.

Hjulfælg: Polypropylen, Hjulbane: TENTEprene, grå termoplastisk gummi, afsmitningsfri, DIN-kugleleje, med trådfang



BETTER MOBILITY. BETTER LIFE.



Picture may differ from original product

Tekniske data

Hjul-Ø	125 mm
Bredde af hjulbane	32 mm
Plademål	77 x 67 mm
Hulafstand	61,5/56 x 51,5/46,5 mm
Pladehul-Ø	8,5 mm
Byggehøjde	160 mm
Temperaturinterval	- 20 / + 60 °C
Standard	EN 12530
Vægt	0.662 kg
Hjulbane hårdhed	Shore A 87
Belastning (dynamisk)	100 kg
Belastning (statisk)	200 kg

Dimensions

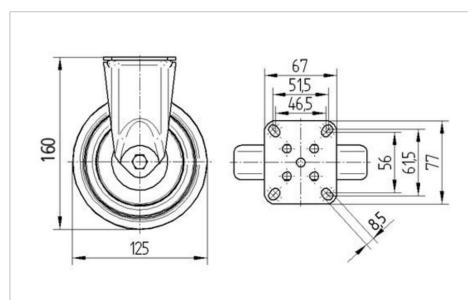

Advantages at a glance

Rulle modstand	● ● ● ○ ○
Kørselsstøj	● ● ● ○ ○
Slid	● ● ● ○ ○
Rustbeskyttelse	● ● ● ○ ○

AGILA

2478PJP125P50

EAN 4031582030389



BETTER MOBILITY. BETTER LIFE.

Structure & Mounting

