

LED BULKHEAD POLO IP44

KEY FEATURES

- High quality LED ceiling and wall fixture
- Lifetime 50,000 hours
- Integrated LED driver
- Fast and easy installation
- Uniform light distribution
- Possible through-wiring
- Excellent price-quality ratio
- Energy savings up to 50%
- 5 year Pragmalux warranty

APPLICATIONS



Education



Healthcare



Office



Residential

OPTIONS

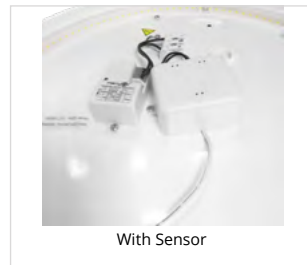

SPECIFICATIONS

Item code	Description	W	lm	lm/W	Kelvin	CRI	Input current	Lifetime L80B10	Equivalent	Beam angle
4600734	LED Bulkhead Polo IP44 12W 3000K Ø280mm	12	1000	83	3000	≥80	0.06A	50,000	18W CFL	120°
4600758	LED Bulkhead Polo IP44 12W 3000K Ø280mm Microwave Sensor	12	1000	83	3000	≥80	0.09A	50,000	18W CFL	120°
4600741	LED Bulkhead Polo IP44 12W 4000K Ø280mm	12	1100	92	4000	≥80	0.06A	50,000	18W CFL	120°
4600765	LED Bulkhead Polo IP44 12W 4000K Ø280mm Microwave Sensor	12	1100	92	4000	≥80	0.09A	50,000	18W CFL	120°
4600772	LED Bulkhead Polo IP44 18W 3000K Ø360mm	18	1550	86	3000	≥80	0.09A	50,000	26W CFL	120°
4600796	LED Bulkhead Polo IP44 18W 3000K Ø360mm Microwave Sensor	18	1550	86	3000	≥80	0.14A	50,000	26W CFL	120°
4600789	LED Bulkhead Polo IP44 18W 4000K Ø360mm	18	1700	94	4000	≥80	0.09A	50,000	26W CFL	120°
4600802	LED Bulkhead Polo IP44 18W 4000K Ø360mm Microwave Sensor	18	1700	94	4000	≥80	0.14A	50,000	26W CFL	120°
4600819	LED Bulkhead Polo IP44 22W 3000K Ø410mm	22	1950	89	3000	≥80	0.10A	50,000	32W CFL	120°
4600833	LED Bulkhead Polo IP44 22W 3000K Ø410mm Microwave Sensor	22	1950	89	3000	≥80	0.17A	50,000	32W CFL	120°
4600826	LED Bulkhead Polo IP44 22W 4000K Ø410mm	22	2075	94	4000	≥80	0.10A	50,000	32W CFL	120°
4600840	LED Bulkhead Polo IP44 22W 4000K Ø410mm Microwave Sensor	22	2075	94	4000	≥80	0.17A	50,000	32W CFL	120°

TECHNICAL DATA

Electrical data	
Voltage (V)	220-240
Frequency (Hz)	50/60
Power factor (λ)	≥ 0.9 (w/o Sensor) / ≥ 0.8 (w/ Sensor)
Operating mode	Integrated LED Driver
Electrical connection	Max 3x2.5 mm ² wire
Total harmonic distortion	≤ 20 %

Temperatures & operating conditions	
Ambient temperature	25°C
Operating temperature	-20 ~ +40°C
Storage temperature	-20 ~ +60°C

Colors & materials	
Color (Housing)	White (RAL9016)
Material (Housing)	Steel
Material (Diffuser)	PMMA

Certificates & standards	
Driver certificates	CE
Fixture certificates	CE
Ingress protection	IP44
Protection class	I
Protection class IK	03
Glow Wire Test (IEC 695-2-1)	650°C
Photobiological safety group EN62778	RG0

Capabilities	
UGR	≤ 23
Dimmable	No
Type of connection	Push Terminal, 3-pole
LED Module replacable	No
Installation	Wall-/Surface Mounted Through-wiring Possible

SPECIFICATIONS DRIVERS

Item code	Description	Driver failure rate at 5,000h	Inrush current Ipeak	Inrush current Twidth	Max. No. of drivers on MCB Type B 10A	Max. No. of drivers on MCB Type B 16A	Max No. of drivers on MCB Type C 10A	Max. No. of drivers on MCB Type C 16A
4600734	LED Bulkhead Polo IP44 12W 3000K Ø280mm	$\leq 1\%$	<15A	680 μ s				
4600758	LED Bulkhead Polo IP44 12W 3000K Ø280mm Microwave Sensor	$\leq 1\%$	<15A	680 μ s				
4600741	LED Bulkhead Polo IP44 12W 4000K Ø280mm	$\leq 1\%$	<15A	680 μ s				
4600765	LED Bulkhead Polo IP44 12W 4000K Ø280mm Microwave Sensor	$\leq 1\%$	<15A	680 μ s				
4600772	LED Bulkhead Polo IP44 18W 3000K Ø360mm	$\leq 1\%$	<15A	680 μ s				
4600796	LED Bulkhead Polo IP44 18W 3000K Ø360mm Microwave Sensor	$\leq 1\%$	<15A	680 μ s				
4600789	LED Bulkhead Polo IP44 18W 4000K Ø360mm	$\leq 1\%$	<15A	680 μ s				
4600802	LED Bulkhead Polo IP44 18W 4000K Ø360mm Microwave Sensor	$\leq 1\%$	<15A	680 μ s				
4600819	LED Bulkhead Polo IP44 22W 3000K Ø410mm	$\leq 1\%$	<15A	680 μ s				
4600833	LED Bulkhead Polo IP44 22W 3000K Ø410mm Microwave Sensor	$\leq 1\%$	<15A	680 μ s				
4600826	LED Bulkhead Polo IP44 22W 4000K Ø410mm	$\leq 1\%$	<15A	680 μ s				
4600840	LED Bulkhead Polo IP44 22W 4000K Ø410mm Microwave Sensor	$\leq 1\%$	<15A	680 μ s				

DIMENSIONS

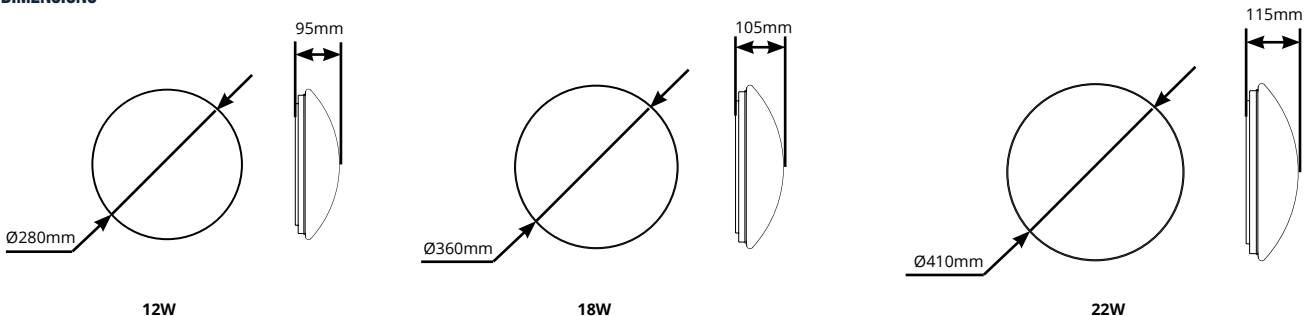

PRAGMALUX

All rights reserved. Pragmalux - PDL Lighting Group B.V. retains the right to modify product specifications without any prior notice or obligation and does not assume any liability for any consequences of using this document. Subject to errors and printing errors. Luminous flux tolerance: +/- 10%. Power consumption tolerance: +/- 10%.

Version: August 2019

ACCESSORIES

Item code	Description
4600857	LED Bulkhead Polo IP44 PMMA Cover Ø280mm
4600864	LED Bulkhead Polo IP44 PMMA Cover Ø360mm
4600871	LED Bulkhead Polo IP44 PMMA Cover Ø410mm



4600857



4600864



4600871

PHOTOMETRIC SPECIFICATIONS

LED Bulkhead Polo IP44 12W 3000K

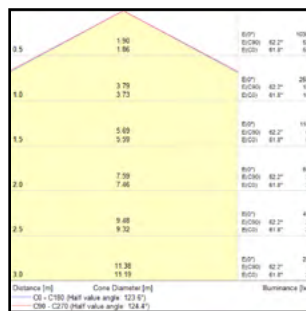
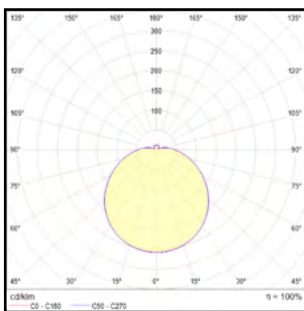

LED Bulkhead Polo IP44 12W 4000K

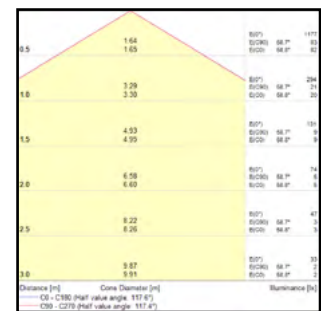
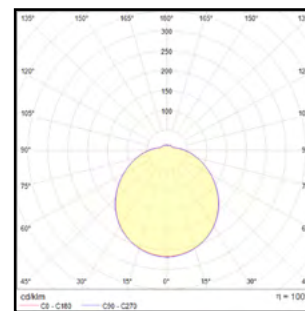

LED Bulkhead Polo IP44 18W 3000K

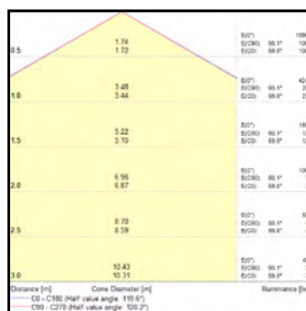
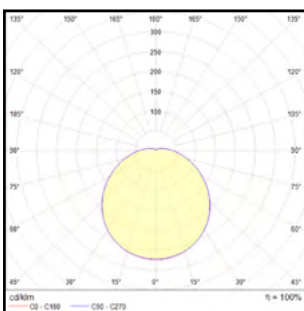

LED Bulkhead Polo IP44 18W 4000K

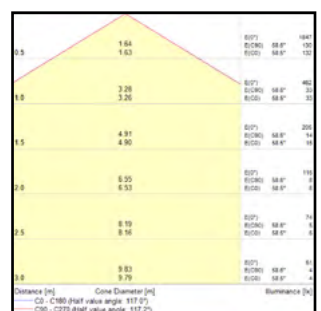
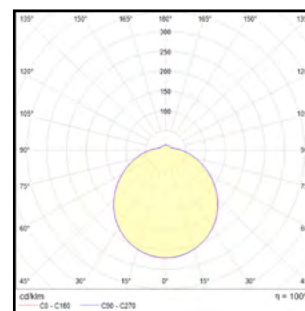

LED Bulkhead Polo IP44 22W 3000K

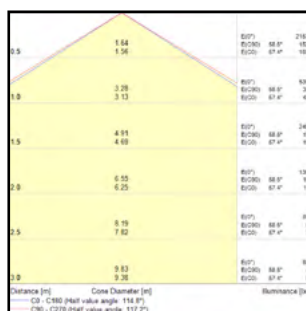
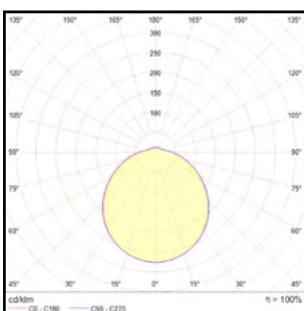

LED Bulkhead Polo IP44 22W 4000K

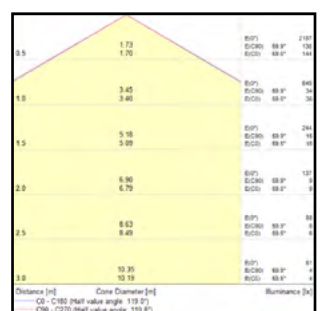
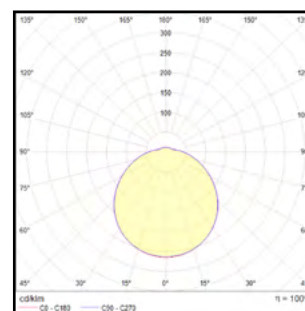

PRAGMALUX

All rights reserved. PragmaLux - PDL Lighting Group B.V. retains the right to modify product specifications without any prior notice or obligation and does not assume any liability for any consequences of using this document. Subject to errors and printing errors. Luminous flux tolerance: +/- 10%. Power consumption tolerance: +/- 10%.

Version: August 2019

PACKAGING INFORMATION

Item code	Description	Single box		Master carton		
		Dimensions(LxWxH) (mm)	Weight(kg)	Units per master carton	Dimensions(LxWxH) (mm)	Weight(kg)
4600734	LED Bulkhead Polo IP44 12W 3000K Ø280mm	325x100x325	0.7	10	670x530x350	8
4600758	LED Bulkhead Polo IP44 12W 3000K Ø280mm Microwave Sensor	325x100x325	0.75	10	670x530x350	8.5
4600741	LED Bulkhead Polo IP44 12W 4000K Ø280mm	325x100x325	0.7	10	670x530x350	8
4600765	LED Bulkhead Polo IP44 12W 4000K Ø280mm Microwave Sensor	325x100x325	0.75	10	670x530x350	8.5
4600772	LED Bulkhead Polo IP44 18W 3000K Ø360mm	400x115x400	1.1	5	610x420x425	6.5
4600796	LED Bulkhead Polo IP44 18W 3000K Ø360mm Microwave Sensor	400x115x400	1.15	5	610x420x425	6.75
4600789	LED Bulkhead Polo IP44 18W 4000K Ø360mm	400x115x400	1.1	5	610x420x425	6.5
4600802	LED Bulkhead Polo IP44 18W 4000K Ø360mm Microwave Sensor	400x115x400	1.15	5	610x420x425	6.75
4600819	LED Bulkhead Polo IP44 22W 3000K Ø410mm	450x125x450	1.36	5	660x470x475	7.8
4600833	LED Bulkhead Polo IP44 22W 3000K Ø410mm Microwave Sensor	450x125x450	1.41	5	660x470x475	8
4600826	LED Bulkhead Polo IP44 22W 4000K Ø410mm	450x125x450	1.36	5	660x470x475	7.8
4600840	LED Bulkhead Polo IP44 22W 4000K Ø410mm Microwave Sensor	450x125x450	1.41	5	660x470x475	8

APPLICATIONS

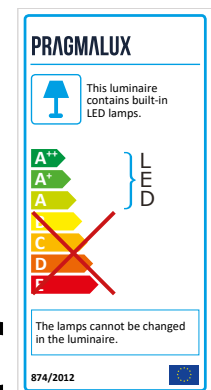

PRAGMALUX

All rights reserved. Pragmalux - PDL Lighting Group B.V. retains the right to modify product specifications without any prior notice or obligation and does not assume any liability for any consequences of using this document. Subject to errors and printing errors. Luminous flux tolerance: +/- 10%. Power consumption tolerance: +/- 10%.

Version: August 2019