

Dealer's Manual

ROAD	MTB	Trekking
City Touring/ Comfort Bike	URBAN SPORT	E-BIKE

HYDRAULIC DISC BRAKE/ DUAL CONTROL LEVER

GRX

ST-RX810
ST-RX600
ST-RX400
BR-RX810
BR-RX400
BL-RX810
BL-RX600

CONTENTS

CONTENTS	2
IMPORTANT NOTICE	4
TO ENSURE SAFETY	5
LIST OF TOOLS TO BE USED	13
INSTALLATION/REMOVAL	14
Installing the dual control lever/brake lever	14
Installing the disc brake rotor	16
Installing the brake caliper	16
• Installing the brake pads	16
• Installing to the frame	17
Installing the brake hose	30
• Overview of the easy hose joint system	30
• Checking the length of the hose	30
• Cutting the hose	32
• Connecting the hose	39
Installing the shifting cable	43
• Cables used	43
• Outer cap with tongue installation position	44
• Cutting the outer casing	45
• Passing through the shifting inner cable	46
ADJUSTMENT	49
Adjusting the reach	49
Adjusting the free stroke	50
MAINTENANCE	52
Replacing the brake pads	52
SHIMANO genuine mineral oil replacement	55
• Draining the mineral oil	55
• Adding mineral oil and bleeding air	58



Replacing the brake hose	72
• Checking and cutting the hose length.....	72
• For the lever side	73
• For the caliper side	75
Adjustment when the pistons are not operating correctly	77
Replacing the name plate.....	78
Replacing the bracket cover	79
Replacing the main lever support.....	80
Replacing the cable cover.....	83
Pulling out a disconnected inner end (shifting cable).....	84
Replacing the SL cable guide.....	85

IMPORTANT NOTICE

- **This dealer's manual is intended primarily for use by professional bicycle mechanics.**
Users who are not professionally trained for bicycle assembly should not attempt to install the components themselves using the dealer's manuals.
If any part of the information on the manual is unclear to you, do not proceed with the installation. Instead, consult a place of purchase or a bicycle dealer for their assistance.
- Make sure to read all owner's manuals included with the product.
- Do not disassemble or modify the product other than as stated in the information contained in this dealer's manual.
- All owner's manuals and dealer's manuals can be viewed on-line on our website (<http://si.shimano.com>).
- For consumers who do not have easy access to the internet, please contact a SHIMANO distributor or any of the SHIMANO offices to obtain a hardcopy of the User's Manual.
- Please observe the appropriate rules and regulations of the country, state or region in which you conduct your business as a dealer.

For safety, be sure to read this dealer's manual thoroughly before use, and follow it for correct use.

The following instructions must be observed at all times in order to prevent personal injury and physical damage to equipment and surroundings.
The instructions are classified according to the degree of danger or damage which may occur if the product is used incorrectly.

 DANGER	Failure to follow the instructions will result in death or serious injury.
 WARNING	Failure to follow the instructions could result in death or serious injury.
 CAUTION	Failure to follow the instructions could cause personal injury or physical damage to equipment and surroundings.

TO ENSURE SAFETY

⚠ WARNING

- Be sure to follow the instructions provided in the owner's manuals when installing the product.

It is recommended to use SHIMANO genuine parts only. If parts such as bolts and nuts become loose or damaged, the bicycle may suddenly fall over, which may cause serious injury.

In addition, if adjustments are not carried out correctly, problems may occur, and the bicycle may suddenly fall over, which may cause serious injury.

-  Be sure to wear safety glasses or goggles to protect your eyes while performing maintenance tasks such as replacing parts.
- After reading the dealer's manual thoroughly, keep it in a safe place for later reference.

Be sure to also inform users of the following:

- Each bicycle may handle slightly differently depending on the model.
Therefore, be sure to learn the proper braking technique (including brake lever pressure and bicycle control characteristics) and operation of your bicycle. Improper use of your bicycle's brake system may result in a loss of control or a fall, which could lead to severe injury. For proper operation, consult a professional bicycle dealer or the bicycle's owner's manual. It is also important to practice riding and braking, etc.
- Please make sure to keep your fingers away from the rotating disc brake rotor. The disc brake rotor is sharp enough to inflict severe injury to your fingers if caught in the openings of the disc brake rotor while it is moving.



- The calipers and disc brake rotor will become hot when the brakes are operated; do not touch them while riding or immediately after dismounting from the bicycle. Otherwise, you may get burned.
- Be careful not to allow any oil or grease to get onto the disc brake rotor and brake pads. Otherwise, the brakes may not work correctly.
- If any oil or grease does get on the brake pads, you should consult a place of purchase or a distributor. Otherwise, the brakes may not work correctly.

- If noise occurs during brake operation, the brake pads may have been worn down to the usable limit. Check that brake system temperature has cooled down sufficiently and then check the thickness of the brake pad. If the thickness is 0.5 mm or less, the brake pad needs to be replaced with a new one. Consult a place of purchase or a distributor.

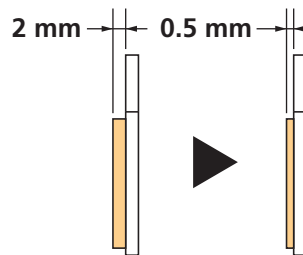

- If the disc brake rotor is cracked or deformed, immediately stop using the brakes and consult a place of purchase or a distributor.
- If the disc brake rotor becomes worn down to a thickness of 1.5 mm or less, or if the aluminum surface appears, immediately stop using the brakes and consult a place of purchase or a distributor. The disc brake rotor may break, and you may fall off the bicycle.
- Vapor lock may occur if the brakes are applied continuously. To solve this problem, momentarily release the lever.
Vapor lock occurs when the oil inside the brake system becomes heated, which causes the water or air bubbles inside the brake system to expand. This can then result in a sudden increase in the brake lever stroke.
- The disc brake is not designed to work when the bicycle is upside down. If the bicycle is turned upside down or on its side, the brake may not work correctly, and a serious accident could occur. Before riding the bicycle, be sure to depress the brake lever a few times to check that the brakes operate normally. If the brakes do not operate normally, stop using the brakes and consult a place of purchase or a distributor.
- If you feel no resistance when depressing the brake lever, immediately stop using the brakes and consult a place of purchase or a distributor.
- If fluid leaks occur, immediately stop using the brakes and consult a place of purchase or a distributor.
- If the front brake is applied too strongly, the wheel may lock and the bicycle may fall forward, and serious injury may result.
- Always make sure that the front and rear brakes are working correctly before riding the bicycle.
- The required braking distance will be longer during wet weather. Reduce your speed and apply the brakes early and gently.
- If the road surface is wet, the tires will skid more easily. If the tires skid, you may fall off the bicycle. Reduce your speed and apply the brakes early and gently.

- The lever should never be altered. Otherwise, the lever may break preventing braking operation.

For installation to the bicycle, and maintenance:

- Please make sure to keep your fingers away from the rotating disc brake rotor during installation or maintenance of the wheel. The disc brake rotor is sharp enough to inflict severe injury to your fingers if caught in the openings of the disc brake rotor while it is moving.



- If the disc brake rotor is cracked or warped, it should be replaced.
- If the disc brake rotor becomes worn down to a thickness of 1.5 mm or if the aluminum surface becomes visible on one side, be sure to replace the disc brake rotor with a new one.
- Check that the brake system has cooled down sufficiently before attempting brake system maintenance.
- Use only SHIMANO genuine mineral oil. If other types of oil are used, it may cause problems with brake operation, and cause vapor lock or the brake system to be unusable.
- Be sure to use only oil from a freshly-opened container, and do not re-use oil which has been drained from the bleed nipple. Old or reused oil may contain water, which could cause vapor lock in the brake system.
- Be careful not to let water or air bubbles get into the brake system. Otherwise, vapor lock may occur. Be particularly careful when removing the cover of the reservoir tank.
- If cutting the brake hose in order to adjust the length of the brake hose, or when changing over the brake hose from left to right or vice versa, be sure to bleed the air from the hose according to steps given in "Adding mineral oil and bleeding air."

- When turning the bicycle upside down or on its side, the brake system may have some air bubbles inside the reservoir tank which are still there when the bleed screw is closed, or which accumulate in various parts of the brake system when it is used for long periods. This disc brake system is not designed to work with the bicycle upside down. If the bicycle is turned upside down or on its side, the air bubbles inside the reservoir tank may move in the direction of the calipers. If the bicycle is ridden in this condition, there is a danger that the brakes may not operate and a serious accident may occur. If the bicycle has been turned upside down or on its side, be sure to depress the brake lever a few times to check that the brakes operate normally before riding the bicycle. If the brakes do not operate normally, adjust them according to the following procedure.

If the brake does not seem to work (feels sluggish) when the lever is depressed

Set the brake lever so that it is parallel to the ground, and then gently depress the brake lever several times and wait for the air bubbles to return to the reservoir tank. It is recommended that you then remove the reservoir tank cover and fill the reservoir tank with mineral oil until no bubbles remain. If the brakes are still sluggish, bleed the air from the brake system. (Refer to "Adding mineral oil and bleeding air.")

- If the quick release lever on the hub is on the same side as the disc brake rotor, they may interfere with each other, which is dangerous, so check that they do not.
- SHIMANO disc brake systems are not compatible with tandem bicycles. Because tandem bicycles are heavier, the stress on the brake system increases during brake operation. If hydraulic disc brakes are used with tandem bicycles, the oil temperature will become too high and vapor locks or ruptures in the brake hoses may occur, causing the brakes to fail.
- When installing a brake caliper that uses a bolt fixing pin, make sure to use a mounting bolt of the appropriate length. Otherwise, the bolt fixing pin will not be engaged properly and the bolt may fall out.

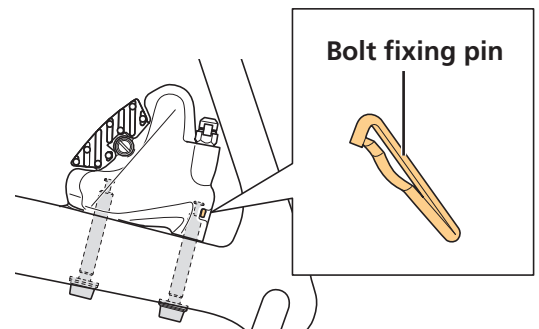

■ Brake hose

- After installing the brake hose to the brake unit, adding SHIMANO genuine mineral oil and bleeding air bubbles, depress the brake lever again several times to check that the brakes are operating normally and there are no fluid leaks from the hose or the system.
- There is a special connector insert for each brake hose. Use the correct connector insert by following the table below. If the wrong connector insert is used, fluid leaks may result.

Brake hose	Connector insert	
	Length	Color
SM-BH90-JK-SSR	11.2 mm	Silver

- Do not reuse the olive piece or the connector insert when reinstalling. A damaged or reused olive, or connector insert, may not provide a secure brake hose connection, possibly causing the brake hose to disconnect from the calipers or brake lever. If the brake hose becomes disconnected, there is a danger that the brakes may suddenly stop working.

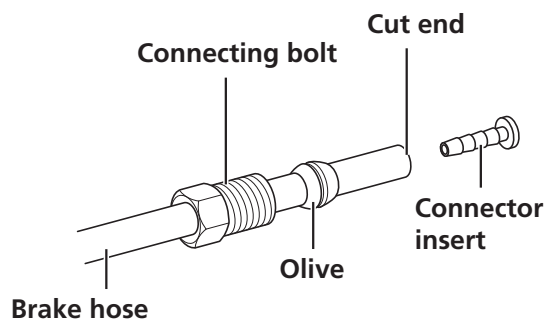

- Cut the brake hose so that the cut end is perpendicular to the length of the hose. If the brake hose is cut at an angle, fluid leaks may result.



⚠ CAUTION**Be sure to also inform users of the following:****■ Cautions on SHIMANO genuine mineral oil**

- Contact with eyes may result in irritation. In the event of contact with eye, wash with water and seek medical attention immediately.
- Contact with skin may cause a rash and discomfort. In the event of contact with skin, wash well with soap and water.
- Inhalation of SHIMANO genuine mineral oil mist or vapors may cause nausea. Cover nose and mouth with a respirator type mask and use in a well ventilated area. If SHIMANO genuine mineral oil mist or vapor is inhaled, cover up with a blanket and go immediately to an area with fresh air. Stay warm and calm, and seek professional medical advice.

■ Burn-in period

- Disc brakes have a burn-in period, and the braking force will gradually increase as the burn-in period progresses. Make sure that you are aware of any such increases in braking force when using the brakes during the burn-in period. The same thing will happen when the brake pads or disc brake rotor are replaced.

For installation to the bicycle, and maintenance:

- When using the SHIMANO original tool (TL-FC36) to remove and install the disc brake rotor fixing ring, be careful not to touch the outside of the disc brake rotor with your hands. Wear gloves to protect your hands from getting cut.

■ Handling SHIMANO genuine mineral oil

- Contact with eyes may result in irritation. Use safety glasses when handling, and avoid contact with eyes. In the event of contact with eye, wash with water and seek medical attention immediately.
- Contact with skin may cause a rash and discomfort. Use gloves when handling. In the event of contact with skin, wash well with soap and water.
- Do not drink. May cause vomiting or diarrhea.
- Keep out of reach of children.
- Do not cut, let near heat, weld or pressurize the oil container, as this may cause explosion or fire.
- Disposal of Used Oil: Follow local county and/or state codes for disposal. Use caution when preparing the oil for disposal.

- Directions: Keep the container sealed to prevent foreign objects and moisture from getting inside, and store it in a cool, dark area away from direct sunlight or heat. Keep from heat or flame, Petroleum Class III, Danger level III

■ When cleaning with a compressor

- If disassembling the caliper main body to clean the internal parts using a compressor, note that moisture from the compressed air may remain on the caliper components. Let the caliper components dry sufficiently before reassembling the calipers.

■ Brake hose

- When cutting the brake hose, handle the knife carefully so as not to cause injury.
- Be careful to avoid injury from the olive.

NOTICE

Be sure to also inform users of the following:

- When the bicycle wheel has been removed, it is recommended that pad spacers are installed. Do not depress the brake lever while the wheel is removed. If the brake lever is depressed without the pad spacers installed, the pistons will protrude further than normal. If that happens, consult a place of purchase.
- Use soapy water and a dry cloth when cleaning and carrying out maintenance of the brake system. Do not use commercially available brake cleansers or silencing agents. Such substances can cause damage to parts such as seals.
- Products are not guaranteed against natural wear and deterioration from normal use and aging.
- For maximum performance we highly recommend SHIMANO lubricants and maintenance products.
- Be sure to keep turning the crank during gear shifting operations.
- Handle the product carefully, and avoid subjecting it to any strong shocks.
- Do not use thinners or similar substances to clean the products. Such substances may damage the surfaces.
- If gear shifting operations do not feel smooth, wash the derailleur and lubricate all moving parts.

















For installation to the bicycle, and maintenance:

- Use a brake hose/outer casing which still has some length to spare even when the handlebars are turned all the way to either side. Furthermore, check that the shifting lever does not touch the bicycle frame when the handlebars are turned all the way.
- Use an OT-SP shield cable and a cable guide for smooth operation.
- Grease the inner cable and the sliding portions of the outer casing before use to ensure that they slide properly. Do not let dust adhere to the inner cable. If the grease on the inner cable is wiped off, the application of SIS SP41 grease (Y04180000) is recommended.
- A special grease is used for the gear shifting cable. Do not use premium grease or other types of grease, otherwise, they may cause deterioration in gear shifting performance.
- If gear shifting adjustments cannot be carried out, check that the fork dropout is aligned. Check whether the cable is clean and greased, and if the outer casing is too long or short.
- Do not remove the lever body.
- If the brake caliper mounting boss and the dropout are outside the specified dimensions, the disc brake rotor and caliper may touch.
- When the bicycle wheel has been removed, it is recommended that pad spacers are installed. The pad spacers will prevent the piston from coming out if the brake lever is depressed while the wheel is removed.
- If the brake lever is depressed without the pad spacers installed, the pistons will protrude further than is normal. Use a flat-shaped tool to push back the brake pads, while being careful not to damage the surfaces of the brake pads. (If the brake pads are not installed, use a flat-shaped tool to push the pistons straight back in, while being careful not to damage them.) If it is difficult to push the brake pads or pistons back, remove the bleed screws and then try again. (Note that some oil may overflow from the reservoir tank at this time.)
- Use isopropyl alcohol, soapy water or a dry cloth when cleaning and carrying out maintenance of the brake system. Do not use commercially available brake cleansers or silencing agents. Such substances can cause damage to parts such as seals.
- Do not remove the pistons when disassembling and cleaning the calipers.
- If the disc brake rotor is worn, cracked or warped, it should be replaced.
- The clamp band, clamp bolt, and clamp nut are not compatible with other products. Do not use them in combination with components used with other products.

The actual product may differ from the illustration because this manual is intended mainly to explain the procedures for using the product.

LIST OF TOOLS TO BE USED

The following tools are needed for installation/removal, adjustment, and maintenance purposes.

Tool	
	2 mm hexagon wrench
	2.5 mm hexagon wrench
	4 mm hexagon wrench
	5 mm hexagon wrench
	8 mm hexagon wrench
	8 mm spanner
	7 mm socket wrench
	Adjustable wrench
	Slotted screwdriver
	Screwdriver [#1]
	TL-BH62
	TL-CT12
	SM-DISC (oil funnel and oil stopper)
	Funnel adapter
	TL-BT03/TL-BT03-S
	TL-LR15

INSTALLATION/REMOVAL

Installing the dual control lever/brake lever

1. Turn over the bracket cover from the rear side.

Gently turn over the ends of the bracket cover with both hands and slowly push them down.

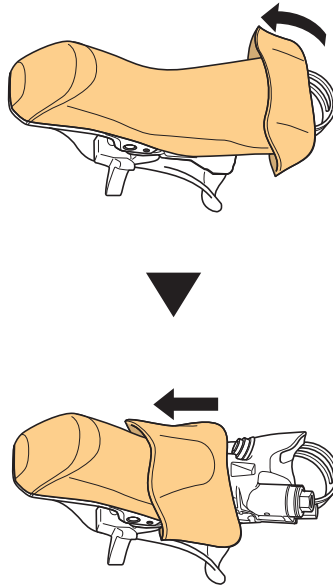

NOTICE

- Forcibly pulling it may cause damage to the bracket cover because of its material properties.

2. Loosen the clamp bolt.

The clamp bolt is on top of a bracket which has had its bracket cover turned over.

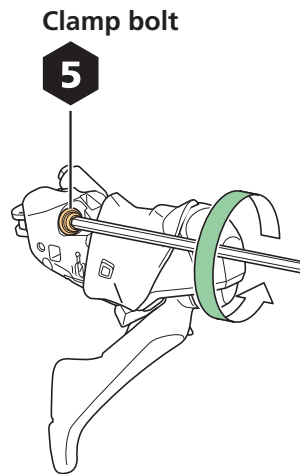

NOTICE

- Loosen the clamp bolt sufficiently. The handlebar may be damaged when passing the lever through the drop handlebar.

3. Install the lever on the handlebar.

Tighten the clamp bolt.

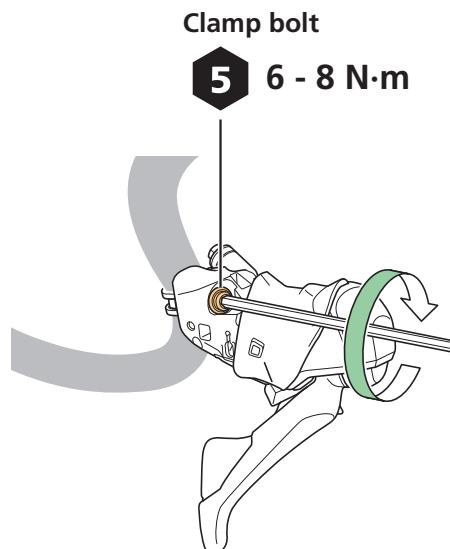

NOTICE

- The clamp band, clamp bolt, and clamp nut are not compatible with other products. Do not use them in combination with components used with other products.

Installing the disc brake rotor

Refer to the dealer's manual for the wheels to install and remove the disc brake rotor.

Installing the brake caliper

Installing the brake pads

1. Remove the bleed spacer (yellow).

- (1) Remove the snap retainer.
- (2) Remove the pad axle.
- (3) Remove the bleed spacer (yellow).

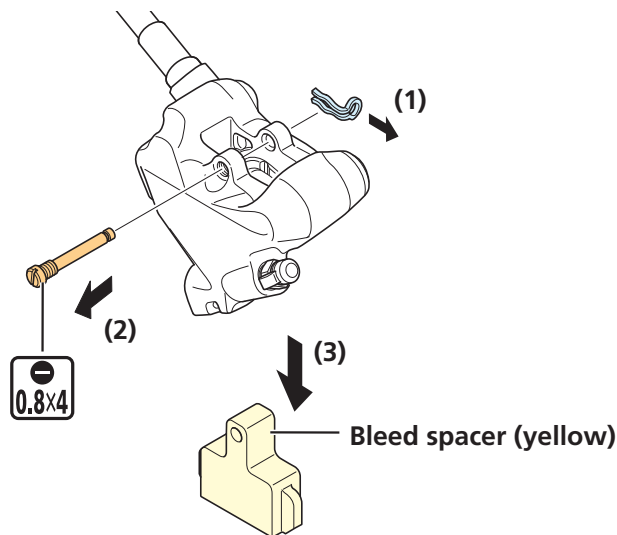

2. Set the pad presser spring in the brake pads.

Since there are fins on the front and rear of the finned pads, set the pads as shown in the figure.

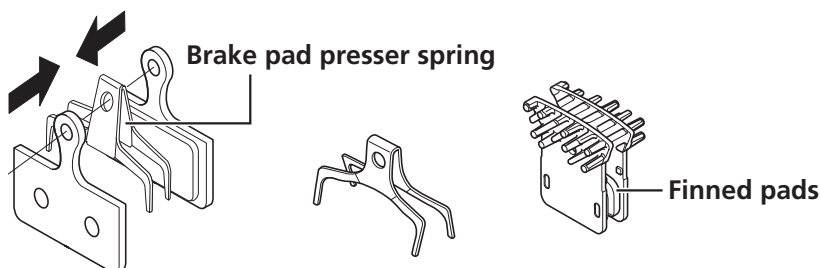

3. Install the brake pads.

- (1) Set the brake pads in the caliper.
- (2) Insert the pad axle.
- (3) Install the snap retainer.

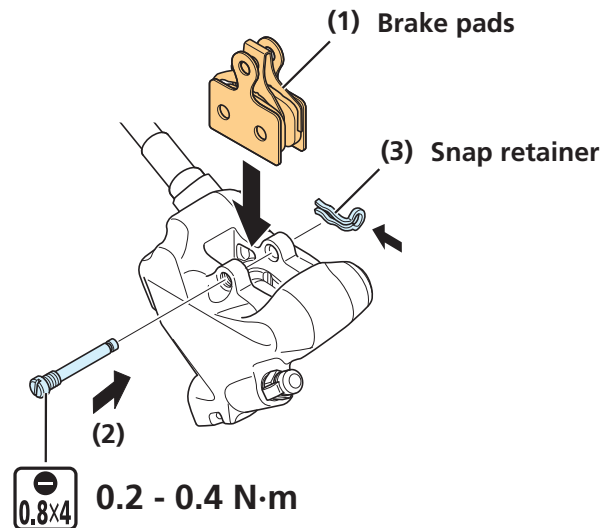

Installing to the frame

Install to the frame the caliper with attached brake pads. The installation method differs according to the disc brake rotor used.

▶ When using a mount bracket (140 mm disc brake rotor)

1. Install the wheel with an attached disc brake rotor onto the frame.

2. Attach the mount bracket to the brake caliper.

- (1) Tighten it using the brake caliper mounting bolt B.
 - (2) Install the bolt fixing pin.
- * Check that the bolt fixing pin has been inserted fully.

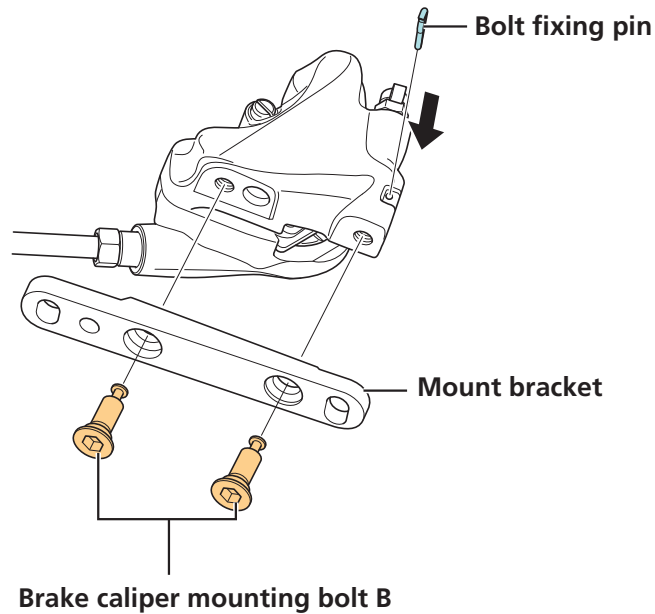

4 6 - 8 N·m

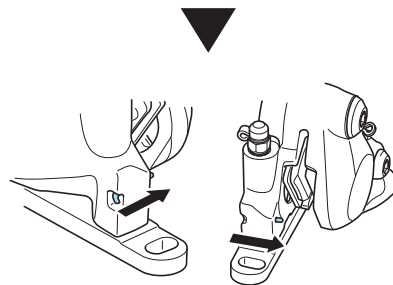

NOTICE

- Pay attention to the marking on the mount bracket when attaching it.

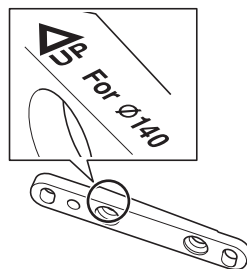

- 3.** Temporarily install the mount bracket to the frame so that it can move left and right.

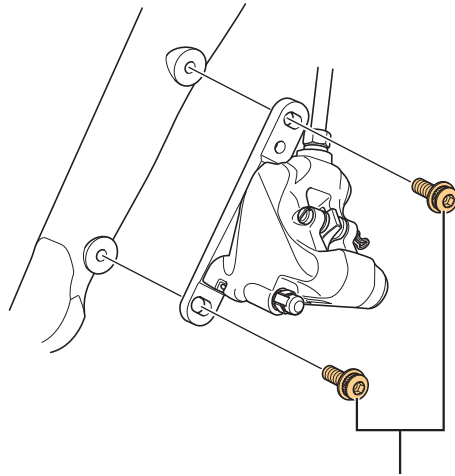

Brake caliper mounting bolt A

4 (temporary)

- 4.** Depress the brake lever so that the disc brake rotor is held between the pads, and then tighten the caliper mounting bolt A.

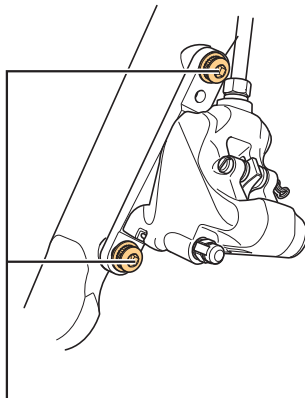

Brake caliper mounting bolt A

4 6 - 8 N·m

- 5.** Install the snap ring.

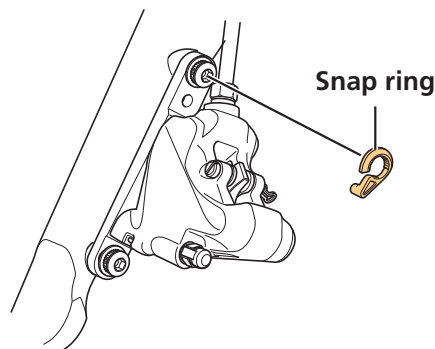

Snap ring

NOTICE

- Positions for attaching snap rings are different for 140 mm and 160 mm disc brake rotors. (The figure indicates the position for a 140 mm disc brake rotor.)

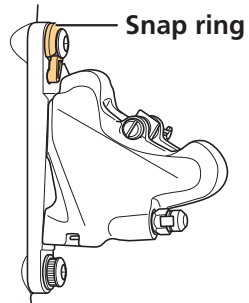
**▶ When using a mount bracket (160 mm disc brake rotor)**

- 1.** Install the wheel with an attached disc brake rotor onto the frame.

2. Attach the mount bracket to the brake caliper.

- (1) Tighten it using the brake caliper mounting bolt B.
 - (2) Install the bolt fixing pin.
- * Check that the bolt fixing pin has been inserted fully.

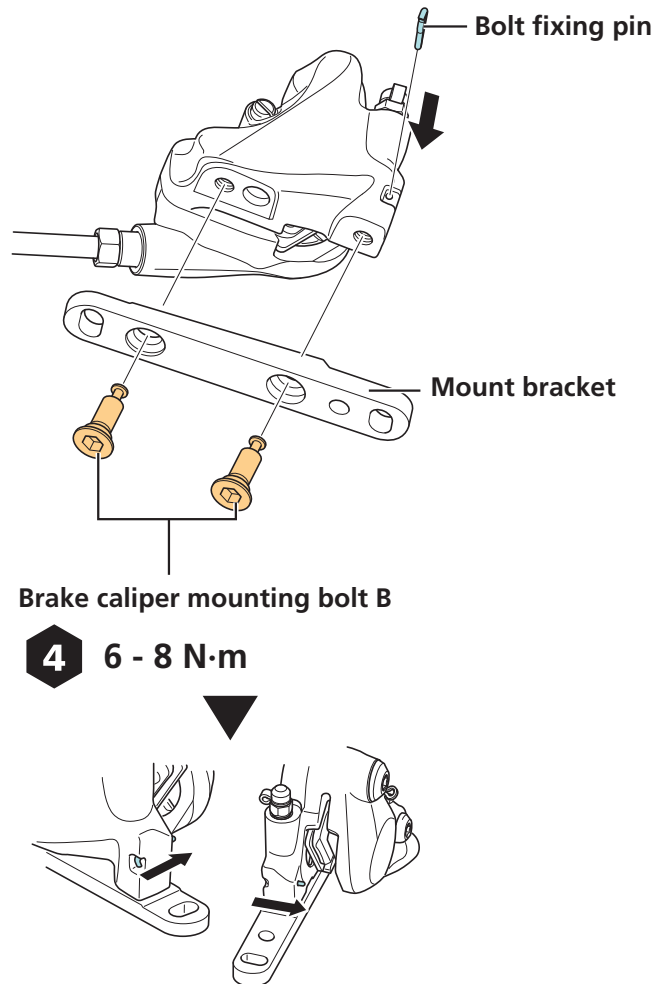

NOTICE

- Pay attention to the marking on the mount bracket when attaching it.

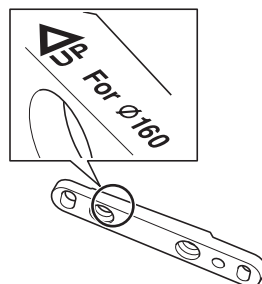

3. Temporarily install the mount bracket to the frame so that it can move left and right.

As indicated in the figure, temporarily install the mount bracket to the frame with the brake caliper mounting bolt A passed through the hole of the mount bracket in advance.

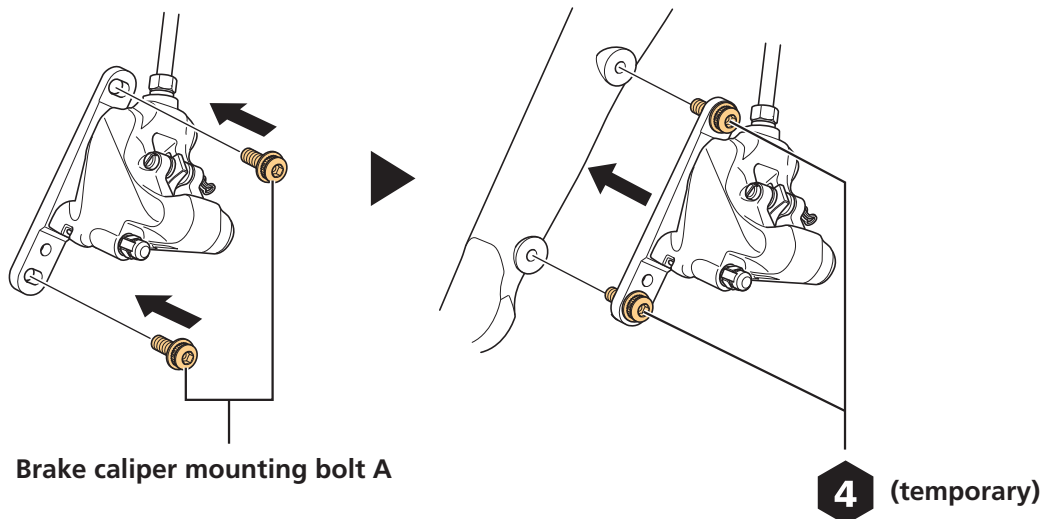

NOTICE

- Do not install the brake caliper mounting bolt A after the mount bracket has come in contact with the frame. Doing so may damage the brake caliper due to interference from the brake caliper.

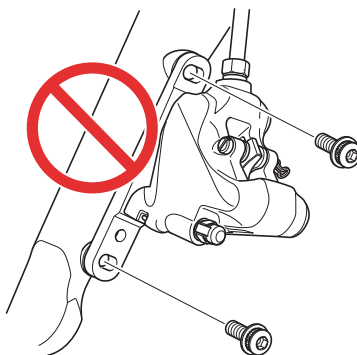

- 4.** Depress the brake lever so that the disc brake rotor is held between the pads, and then tighten the caliper mounting bolt A.

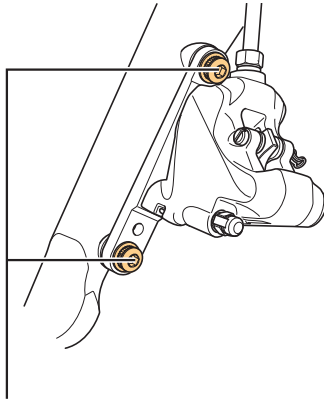

Brake caliper mounting bolt A

4 6 - 8 N·m

- 5.** Install the snap ring.

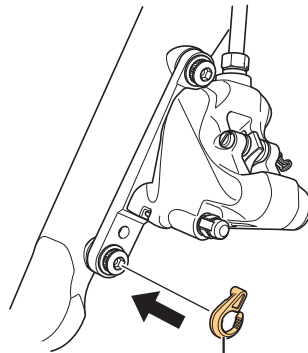

Snap ring

NOTICE

- Positions for attaching snap rings are different for 140 mm and 160 mm disc brake rotors. (The figure indicates the position for a 160 mm disc brake rotor.)

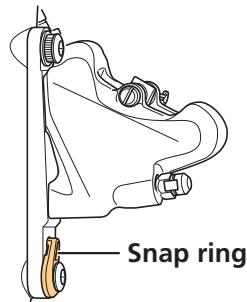

Snap ring

▶ When using the brake caliper mounting bolt C (140 mm disc brake rotor)

1. Insert the brake caliper mounting bolt C into the frame mount area.

Make sure that the length of the protruding section of the brake caliper mounting bolt C is 13 mm.

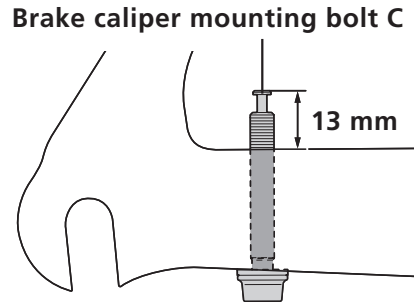

NOTICE

- When using a bolt length selector, make sure the tip of the brake caliper mounting bolt C is within the range A.

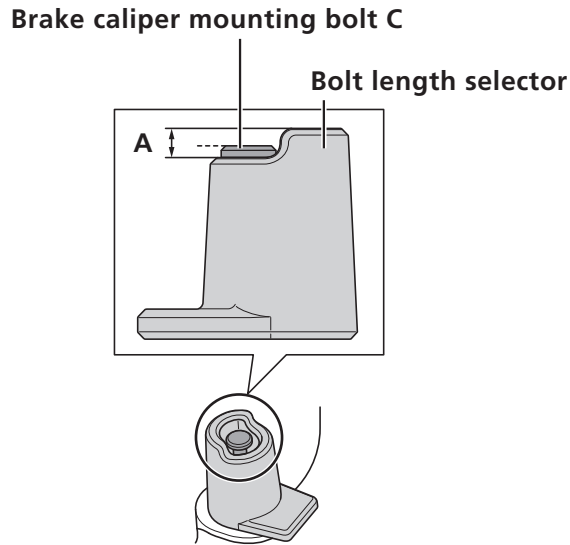

- Do not use a washer when checking the length of the brake caliper mounting bolt C.
- The length of brake caliper mounting bolt C to be used varies depending on the thickness of the frame. Use the brake caliper mounting bolt C that is appropriate for the thickness of the frame.

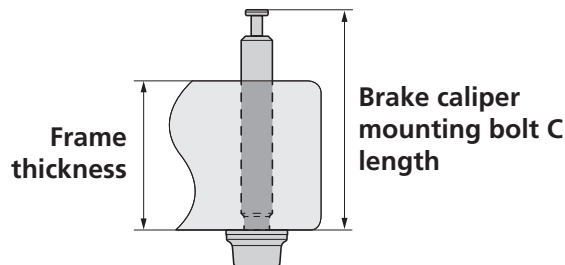

Frame thickness	Brake caliper mounting bolt C length	Y-part
20 mm	33 mm	Y8PU08010
25 mm	38 mm	Y8PU08020
30 mm	43 mm	Y8PU08030

- 2.** Temporarily install the brake caliper to the frame so that the brake caliper can still move horizontally.

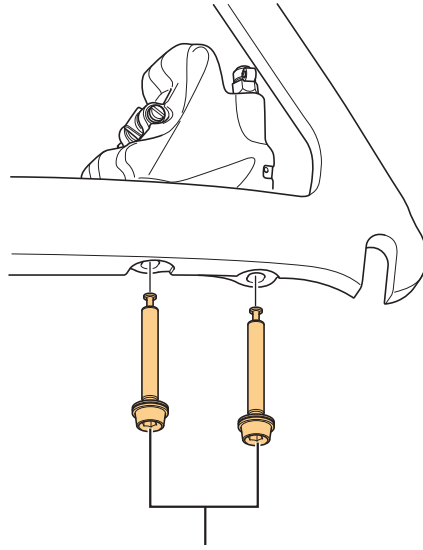

Brake caliper mounting bolt C

4 (temporary)

- 3.** Depress the brake lever so that the disc brake rotor is held between the pads, and then tighten the caliper mounting bolt C.

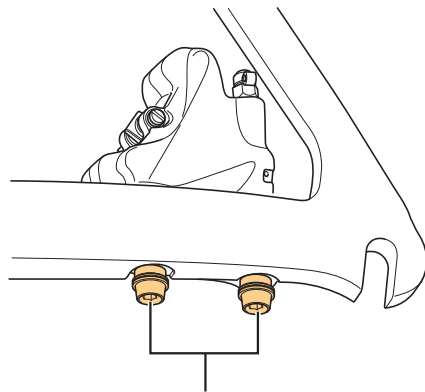

Brake caliper mounting bolt C

4 6 - 8 N·m

4. Install the bolt fixing pin.

Check that the bolt fixing pin has been inserted fully.

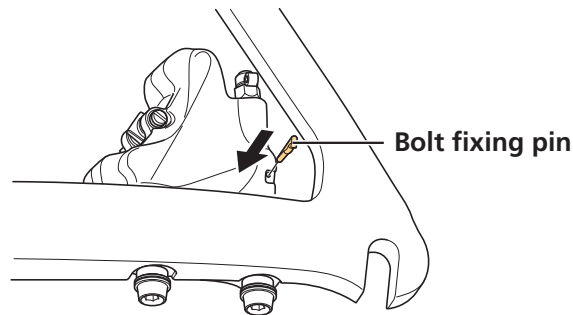

▶ When using the brake caliper mounting bolt C (160 mm disc brake rotor)

1. Check the length of the brake caliper mounting bolt C.

Refer to step 1 in "For a rear 140 mm disc brake rotor".

2. Attach the mount bracket to the brake caliper.

(1) Tighten it using the brake caliper mounting bolt B.

(2) Install the bolt fixing pin.

* Check that the bolt fixing pin has been inserted fully.

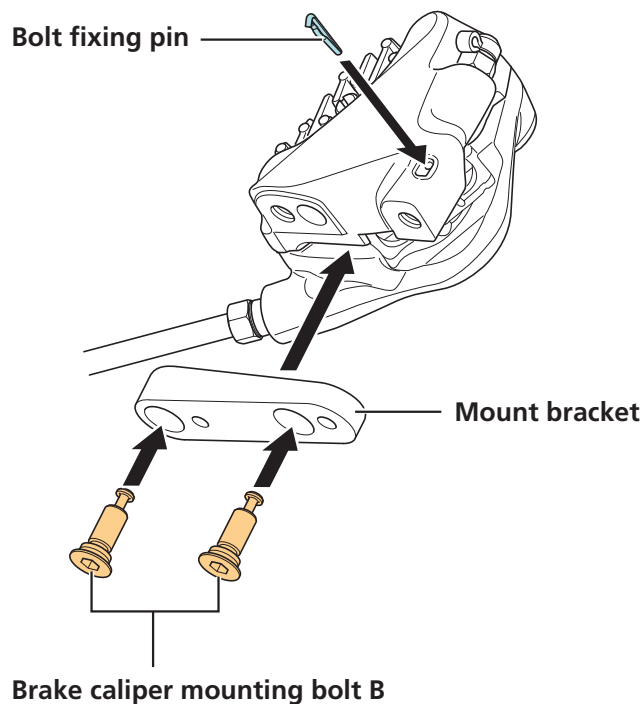

4 6 - 8 N·m

NOTICE

- Pay attention to the marking on the mount bracket when attaching it.



3. Temporarily install the mount bracket to the frame so that it can move left and right.

Temporarily install it using the brake caliper mounting bolt C that has an attached washer.

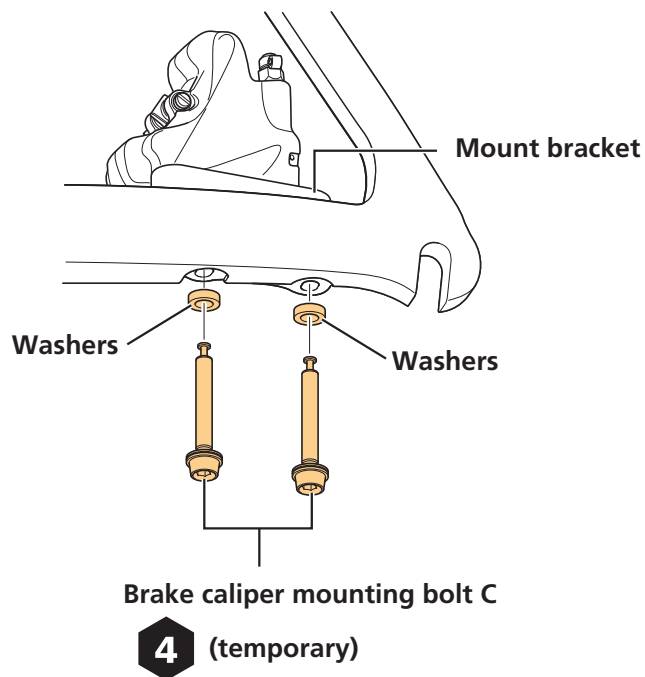

4. Depress the brake lever so that the disc brake rotor is held between the pads, and then tighten the caliper mounting bolt C that has an attached washer.

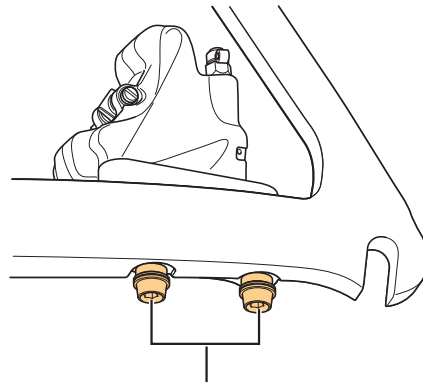

Brake caliper mounting bolt C

4 6 - 8 N·m

5. Install the snap retainer.

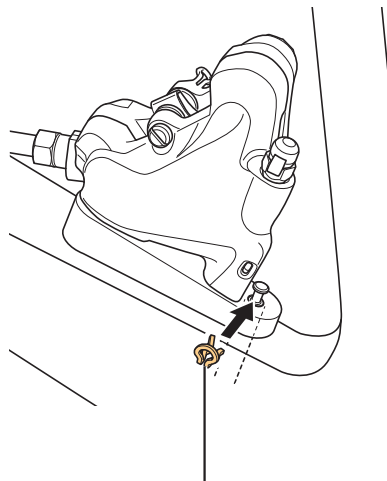

Snap retainer

Installing the brake hose

Overview of the easy hose joint system

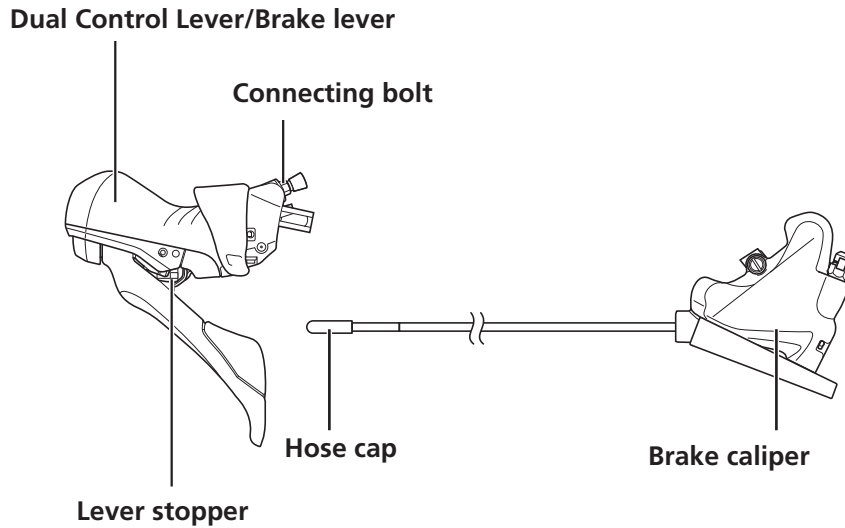

Checking the length of the hose

1. Route the brake hose into the final installation position.

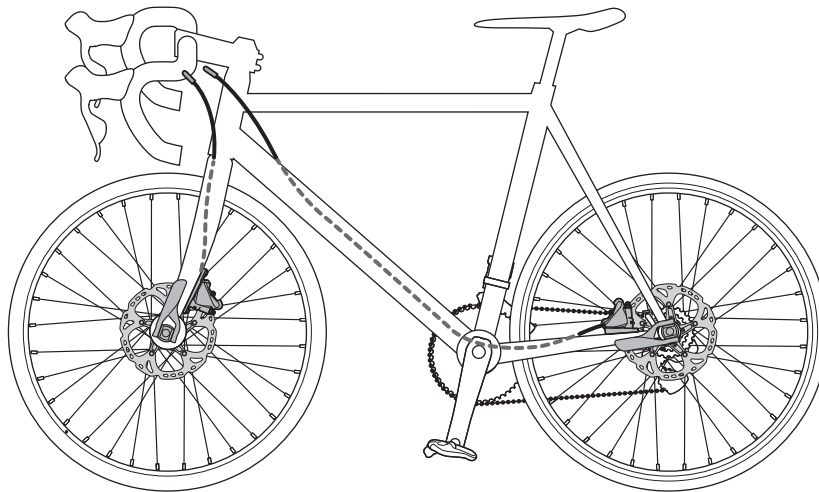

NOTICE

- This figure is only for explanatory purposes. For details on how to route the brake hoses, consult the manufacturer of the bicycle or refer to the bicycle's owner's manual.
- Do not remove the hose caps from the ends of the brake hoses.

2. Check the appropriate length of the brake hose.

Secure the lever in the position used when riding.

Check the mark added beforehand on the brake hose with the edge of the lever connecting bolt.

- * If the hose is at the appropriate length, it is not necessary to cut the hose. Proceed to "Connecting the hose" in "Installing the brake hose."
- * If the hose needs to be shortened, proceed to "Cutting the hose" in "Installing the brake hose."
- * If the hose length is insufficient, replace with a hose that has an appropriate length.

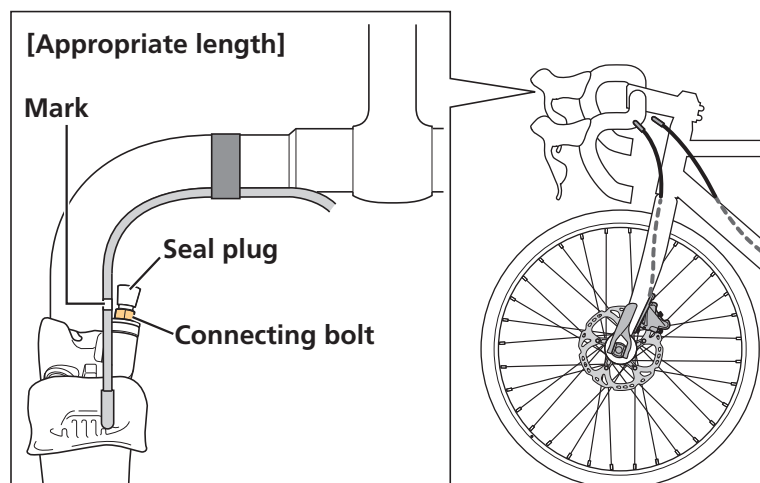

Cutting the hose

Use care when cutting the hose, as oil may leak when the hose is cut.

1. Determine the appropriate length and add a check mark on the brake hose.

Add the mark so it is aligned with the edge of the connecting bolt.

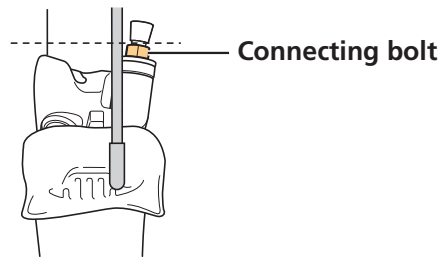

2. Add a cut mark.

Mark the hose at a position 21 mm from the check mark towards the end of the hose.

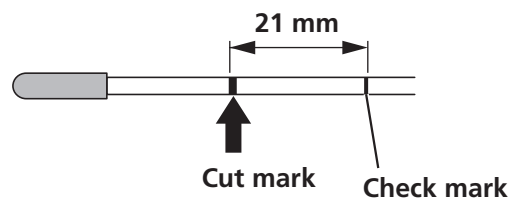

3. Prepare SHIMANO original tool TL-BH62 for cutting the brake hose.

Disassemble the tool as shown in the figure.

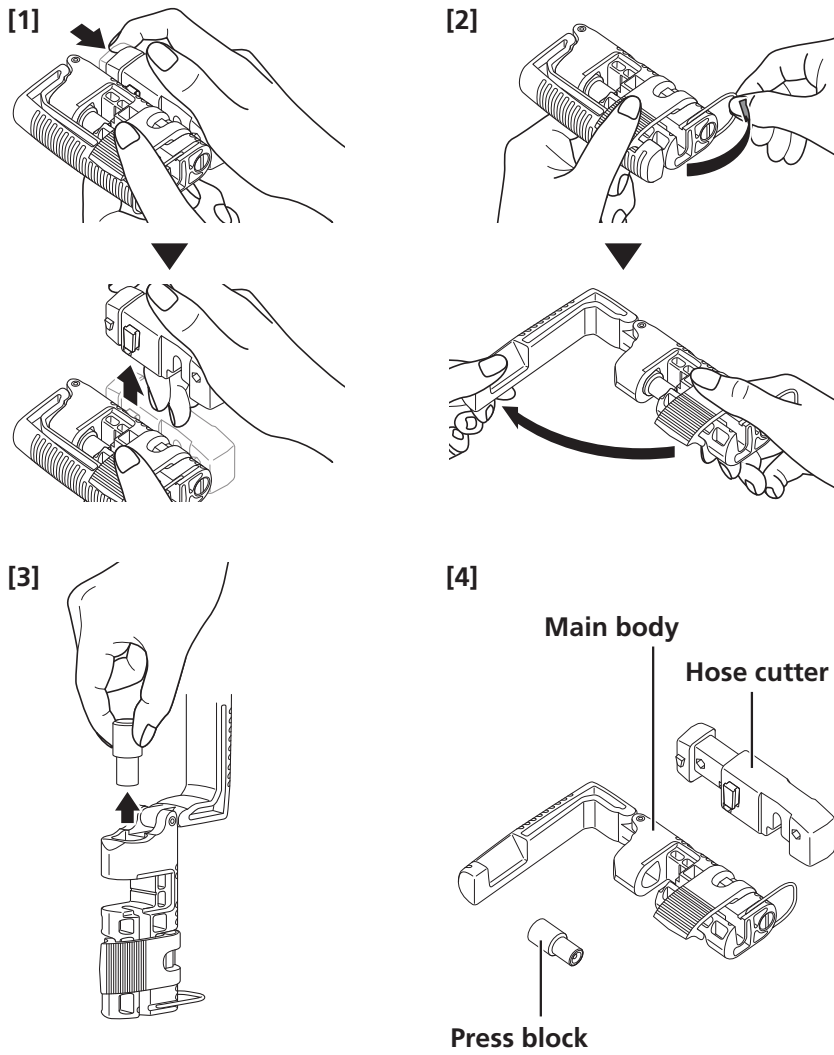

NOTICE

- Make sure to also refer to the owner's manual for SHIMANO original tool TL-BH62.
- Do not move the lever indicated in the figure before disassembling SHIMANO original tool TL-BH62.

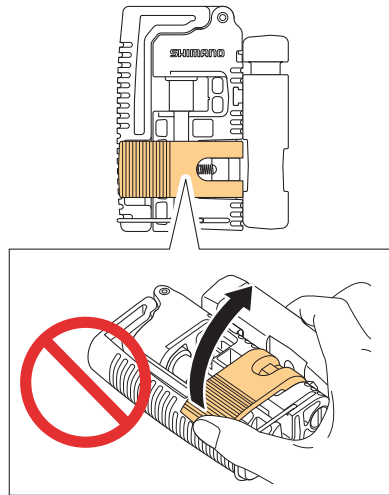

4. Place the brake hose in SHIMANO original tool TL-BH62.

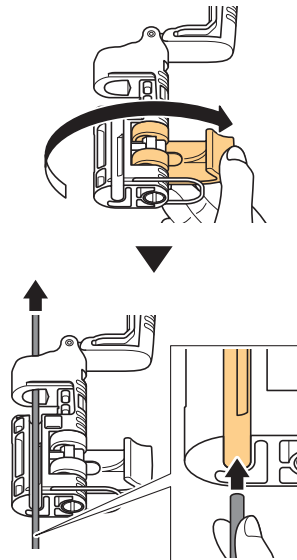

NOTICE

- When inserting the brake hose, make sure that the cut mark is parallel with the groove in the tool.

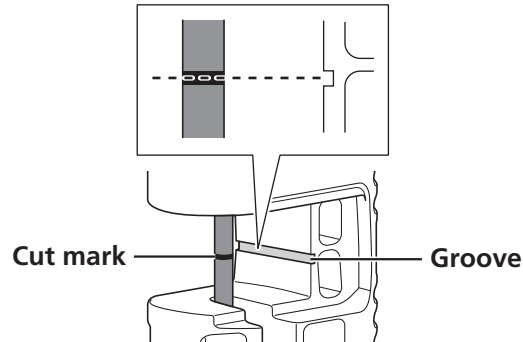

5. Check the cut location and secure the brake hose in place.

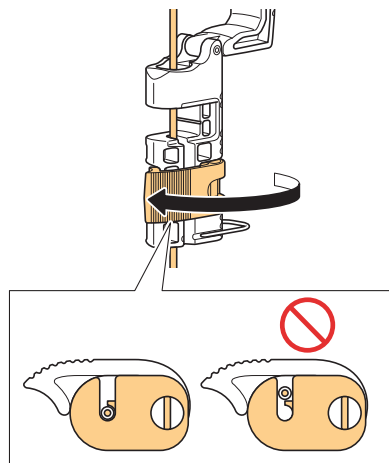

6. Check that the hose is secure, and then install the hose cutter.

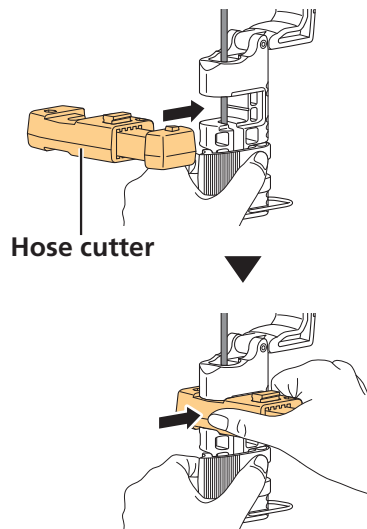

7. Press the hose cutter as shown in the figure to cut the brake hose.

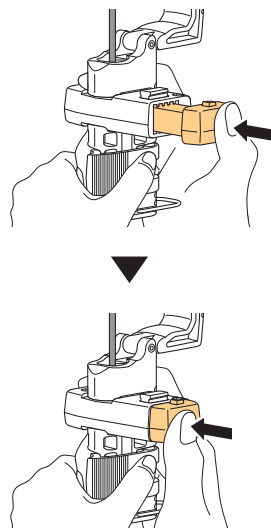

8. Remove the hose cutter and check that the cut end is even.

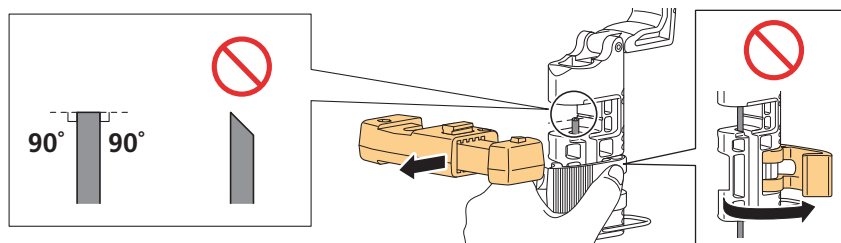

9. Install the connector insert in the press block, and then set the press block in SHIMANO original tool TL-BH62.

Make sure that the tip of the connector insert is correctly positioned inside the opening of the brake hose.

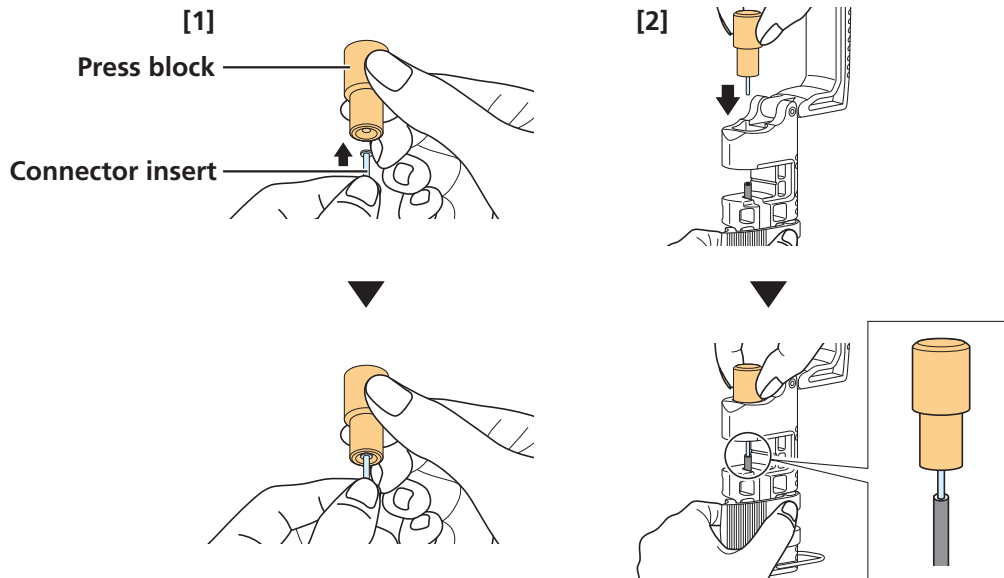

NOTICE

- When connecting with an easy hose joint system, a specialized connector insert (SHIMANO CODE No.: Y8JA98020/color: silver) must be used. If the designated connector insert is not used, the part will become improperly assembled and malfunctions such as oil leakage may occur.

10. Depress the lever on SHIMANO original tool TL-BH62 to install the connector insert in the brake hose.

Check that the connector insert is installed correctly.

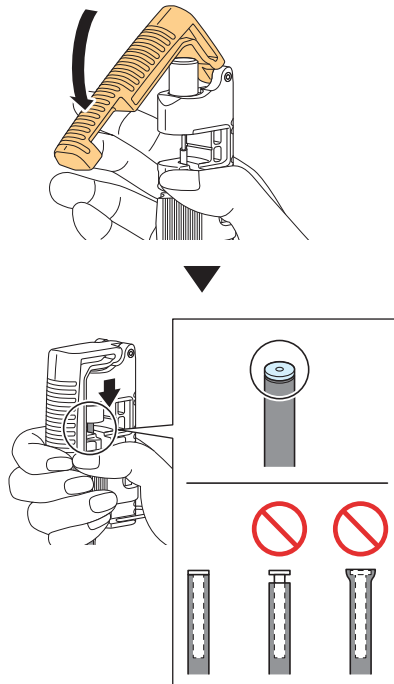

11. Remove the brake hose from SHIMANO original tool TL-BH62.

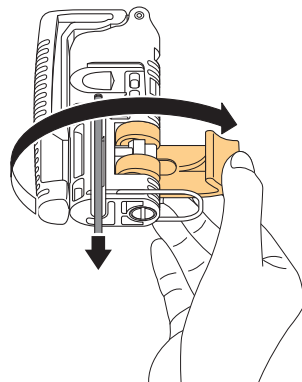

Connecting the hose

1. Remove the hose cap.

If the brake hose was cut, it is not necessary to remove the hose cap.

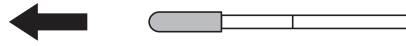

2. Fix the lever with the hose connector facing up by changing the angle of the handle, etc.

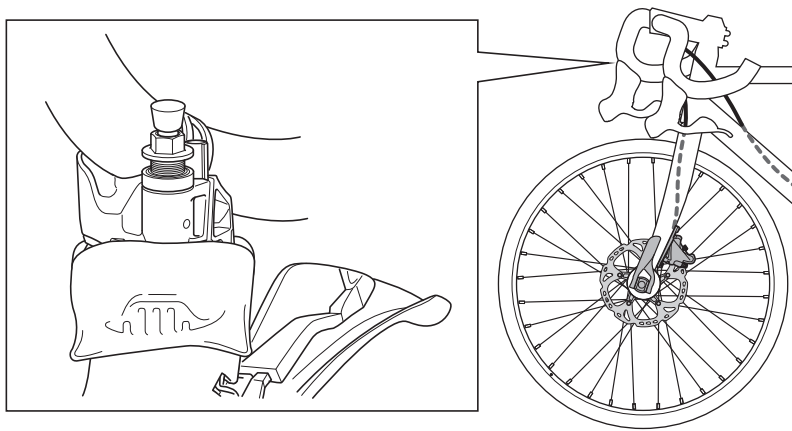

NOTICE

- When attaching to the handlebar, adjust the angle of the bracket by tilting the bracket from the handlebar so that you can turn the spanner. When doing so, take care not to damage the handle, etc.

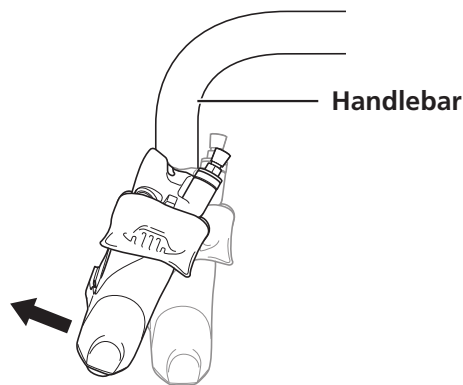

3. Remove the seal plug.

Cover the seal plug with a waste cloth while conducting this procedure as oil that has adhered to the seal plug may leak.

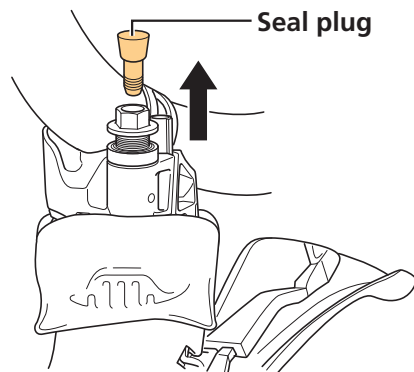

4. Insert the brake hose in the brake hose connection port.

The part comes with a built-in olive. Insert the hose so that it does not become snagged on the olive.

Insert the hose until the check marks on the surface of the hose are covered.

Cover with a waste cloth while conducting this procedure as some of the internal oil may leak.

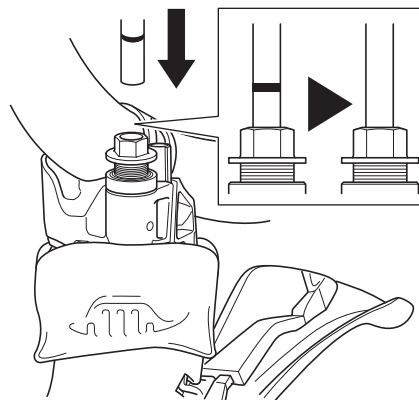

5. Tighten the connecting bolt with flange.

Tighten the bolt while pushing the brake hose in.

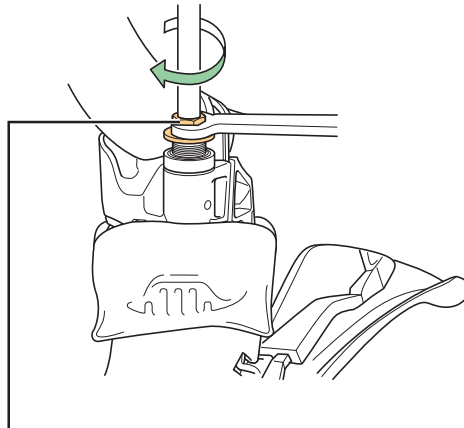

Connecting bolt with flange

 5 - 6 N·m

NOTICE

- Make sure to insert the brake hose and tighten the connecting bolt. Otherwise, oil leaks or insufficient braking force may occur.

6. Wipe away any oil.

7. Remove the lever stopper.

Pull out the lever stopper by means of short back and forth movements. Take care to not depress the lever.

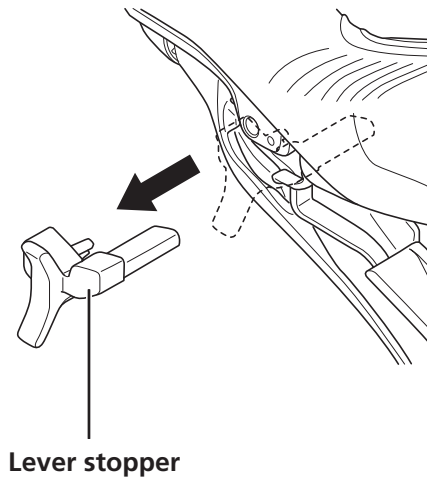

NOTICE

- After removing the lever stopper, check that the pad spacer is installed on the caliper side and that the caliper is installed on the bicycle with the disc brake rotor between both sides of the caliper before depressing the lever. After assembly on the bicycle is complete, make sure that the lever stopper is removed.

8. Check that the lever has become stiff.

If the lever does not become stiff, refer to "Adding mineral oil and bleeding air" and bleed the air from the system.

Installing the shifting cable

Cables used

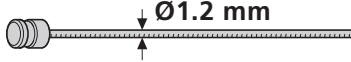
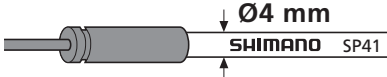
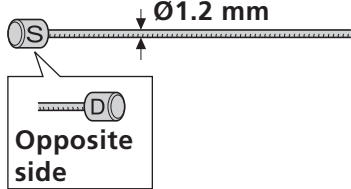
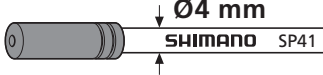
	Designated inner cable	Recommended outer casing
ST-RX810	 <p>Ø1.2 mm</p>	<p>Outer cap with tongue/SP41 outer casing</p>  <p>Ø4 mm SHIMANO SP41</p>
ST-RX600/ ST-RX400	 <p>Ø1.2 mm</p> <p>Opposite side</p>	<p>Normal outer cap/SP41 outer casing</p>  <p>Ø4 mm SHIMANO SP41</p>

NOTICE

- Do not let dust adhere to the inner cable.
- If the grease on the inner cable is wiped off, the application of SIS SP41 grease (Y04180000) is recommended.

Outer cap with tongue installation position

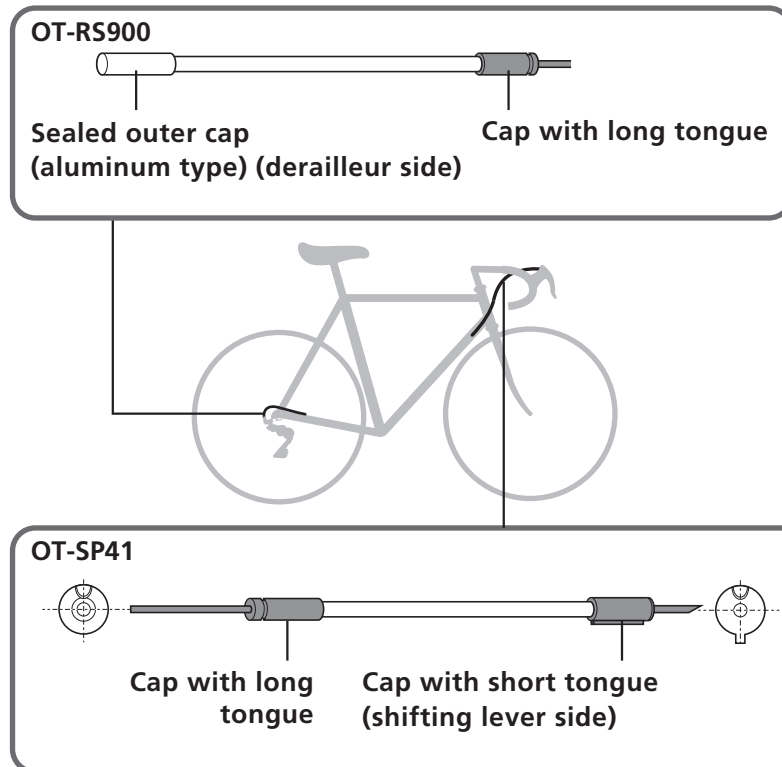

TECH TIPS

- Insert the convex section of the cap with short tongue into the groove of the bracket.

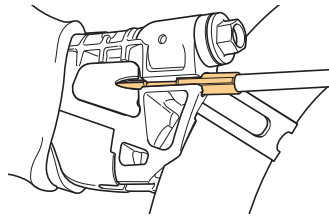

Cutting the outer casing

1. Cut the outer casing using a cable cutter (TL-CT12), etc.

Cut the end of the outer casing that is opposite to the marking.

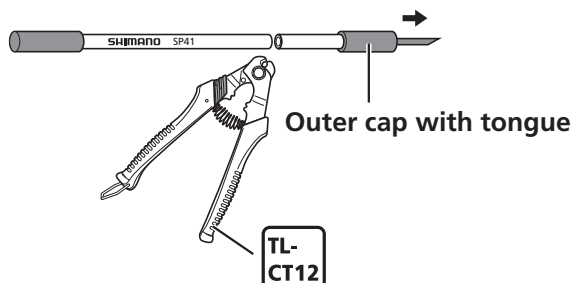

NOTICE

- Use a cable which still has some length to spare even when the handlebars are turned all the way to either side.

2. Remove the outer cap with tongue from the cut outer casing.



3. Spread out the tip of the liner (Ø2.2 or more) using a thin tool such as a TL-CT12 needle.

Arrange the cut end into a perfect circle.

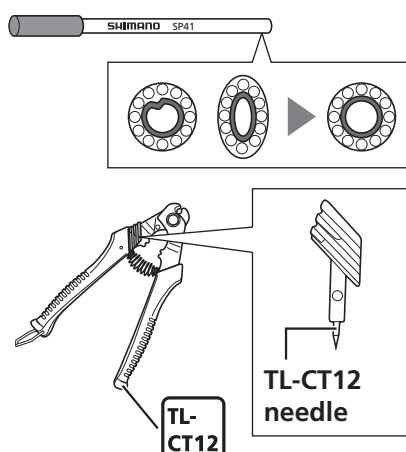

NOTICE

- Be careful not to hurt your hands with the TL-CT12 needle.

4. Install the outer cap with tongue.

Insert the outer casing until it closely contacts with the seating surface of the outer cap with tongue.

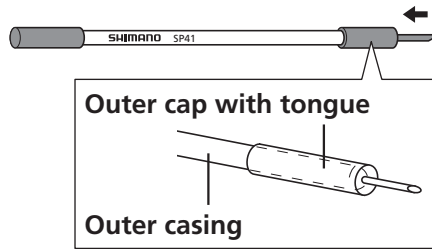

NOTICE

- When inserting the outer casing, take care to ensure that the tip of the outer cap with tongue does not collapse.

Passing through the shifting inner cable

The illustration shows the right hand lever.

1. Set the lever position to the top.

Operate the release lever 10 times or more.

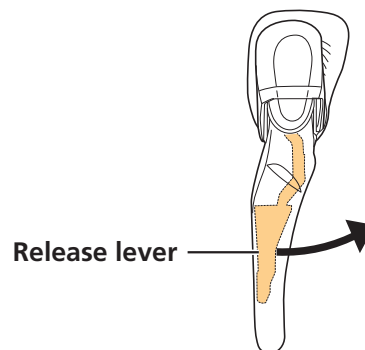

2. Turn over the bracket cover from the rear side.

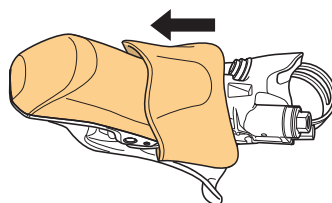

3. Remove the cable cover from the bracket.

Remove it using a screwdriver, etc.

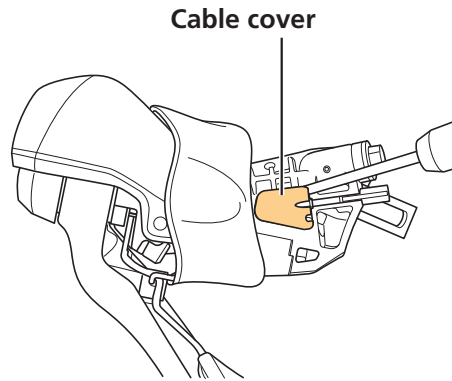

4. Pass the inner cable through as shown in the figure.

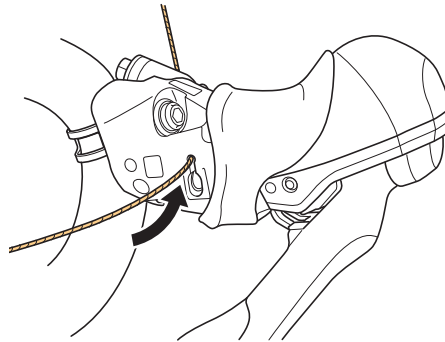

NOTICE

- Insert the cable while being careful not to allow coating on the inner cable to be damaged.

5. Insert the cable in such a manner that the inner end is attached to the unit.

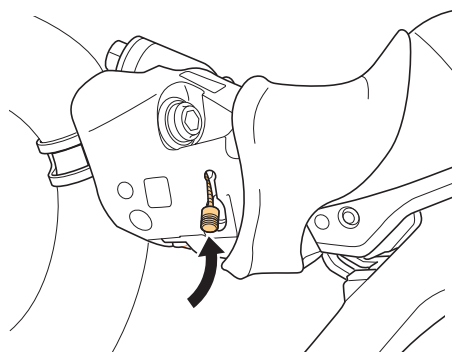

6. Pass the inner cable through as shown in the figure.

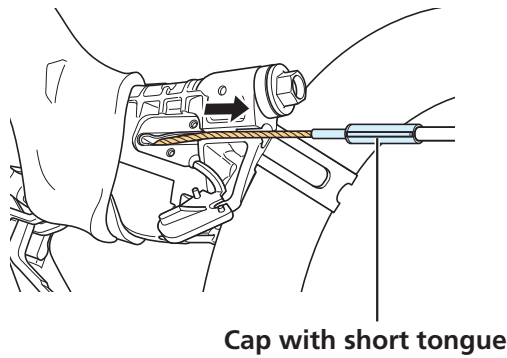

7. Install the cable cover to the bracket.

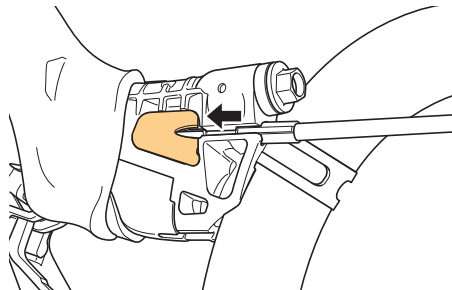

TECH TIPS

- Fuzz may be generated when the coating is damaged during the assembling of the inner cable, but this will not affect the function of the part.

8. Temporarily attach the outer casing to the handlebar using tape, etc.

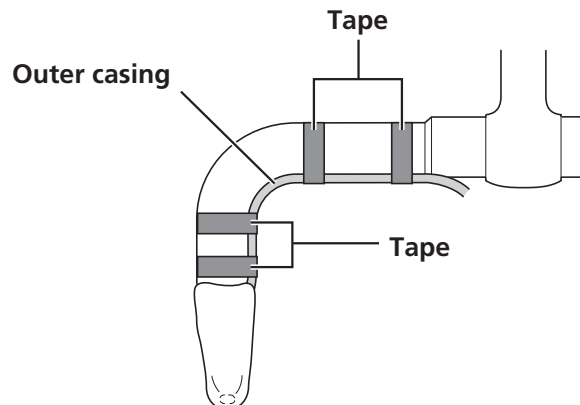

9. Wrap the handlebar with handlebar tape.

ADJUSTMENT

Adjusting the reach

1. Turn the reach adjustment screw to adjust the reach.

ST-RX810/BL-RX810

Tightening the adjustment screw (clockwise) widens the distance between the initial position of the lever and the handlebar, while loosening the screw (counterclockwise) narrows it.

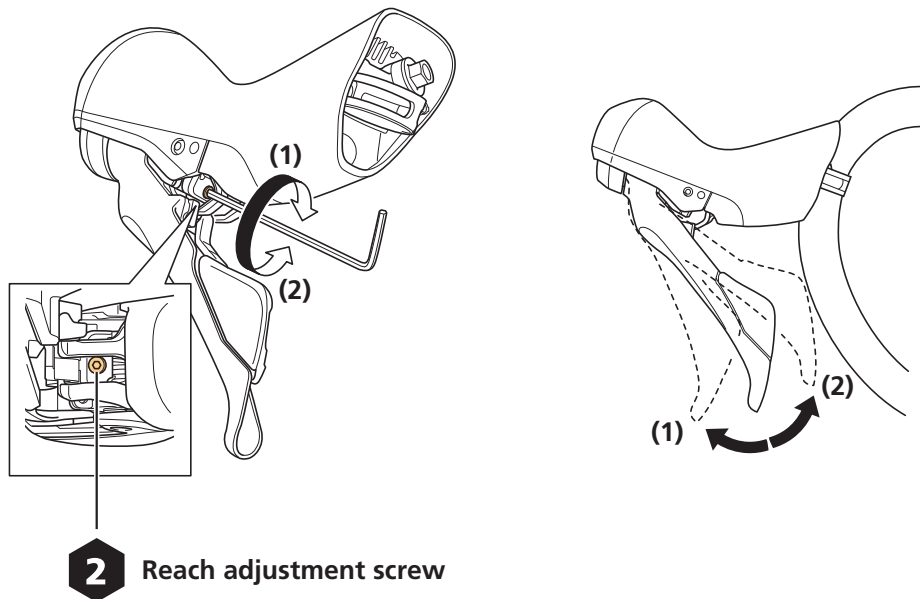

ST-RX400/ST-RX600/BL-RX600

Tightening the adjustment screw (clockwise) narrows the distance between the initial position of the lever and the handlebar, while loosening the screw (counterclockwise) widens it.

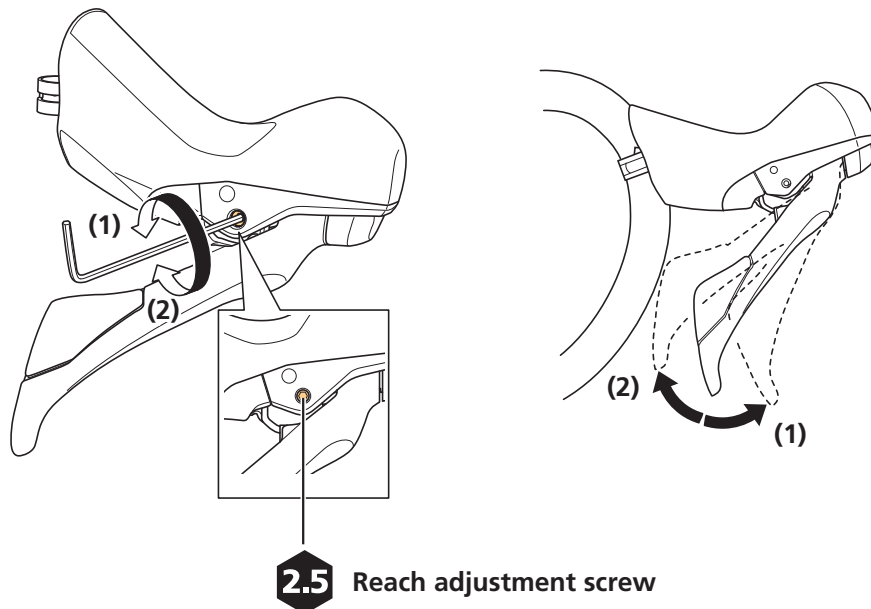
**NOTICE**

- Make sure that braking operates properly after the adjustment.

Adjusting the free stroke

Adjust the range of travel of the lever until the brake pad and disc brake rotor come into contact. Perform reach adjustment if the initial position of the lever changes when performing the free stroke adjustment.

- 1.** Turn over the bracket cover from the rear side.

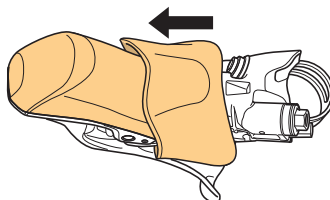

2. Turn the free stroke adjustment screw to adjust the stroke.

Tightening the free stroke adjustment screw (clockwise) narrows the range of travel of the lever, while loosening the screw (counterclockwise) widens it.

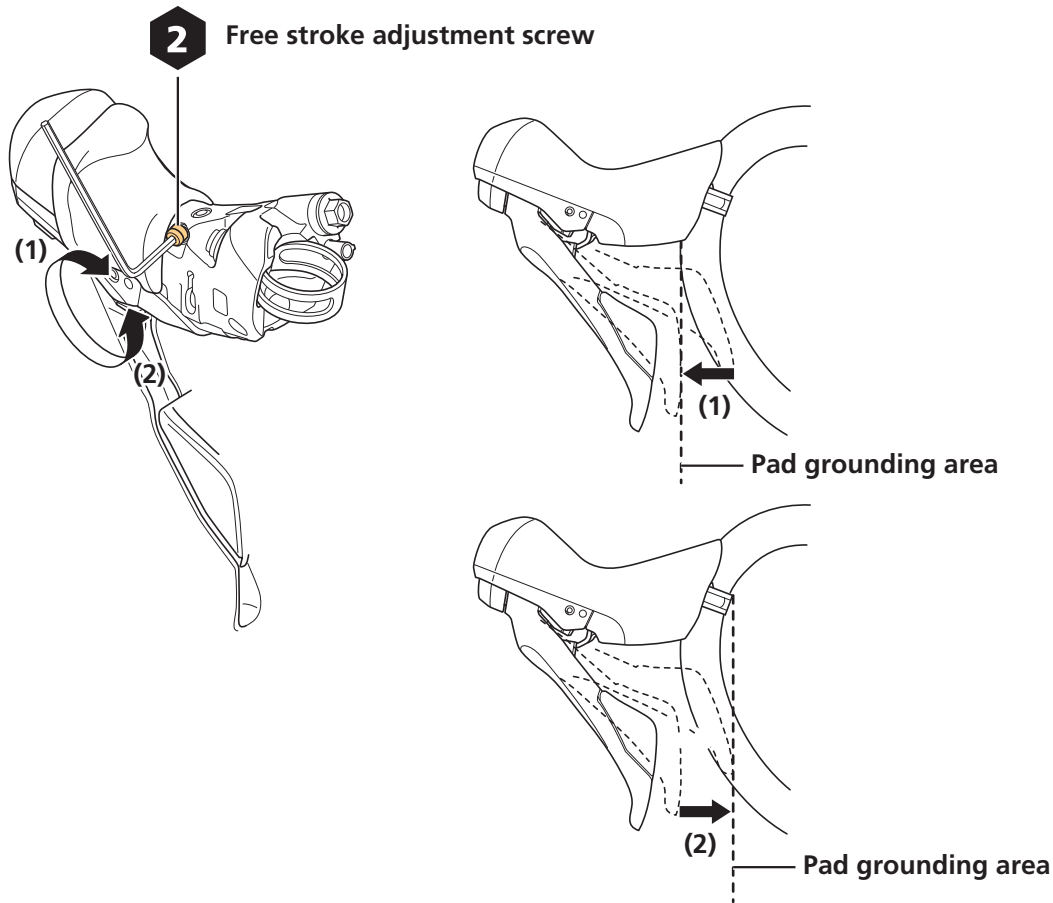

NOTICE

- Free stroke cannot be adjusted for ST-RX400/ST-RX600/BL-RX600.
- Stop loosening the free stroke adjustment screw when the free stroke stops increasing. Loosening the free stroke adjustment screw excessively may cause the screw to be removed from the bracket body. Do not forcibly tighten the free stroke adjustment screw. Otherwise, the adjustment screw may be damaged.
- Do not remove the washer from the free stroke adjustment screw.
- Position the free stroke adjustment screw so that it does not interfere with the bracket cover.

MAINTENANCE

Replacing the brake pads

NOTICE

- This brake system is designed to automatically adjust the clearance between the disc brake rotor and the brake pads by the pistons gradually protruding in relation to the wear of the brake pads. As a result, when the brake pads are replaced, the pistons need to be pushed back into position.

TECH TIPS

- Replace the brake pads in the following circumstances.
 - When oil adheres to the brake pads
 - When the brake pads are worn down to a thickness of 0.5 mm
 - When the brake pad presser spring is interfering with the disc brake rotor

1. Remove the wheel from the frame.

2. Remove the brake pads from the caliper.

- (1) Remove the snap retainer.
- (2) Remove the pad axle.
- (3) Remove the brake pads from the caliper.

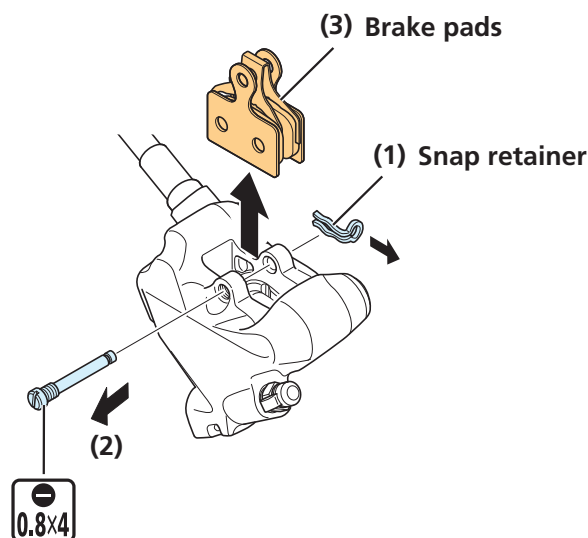

3. Clean the pistons and the surrounding area.

4. Push the pistons straight back as far as they will go.

Use a flat-shaped tool to push the pistons back while being careful not to twist them.

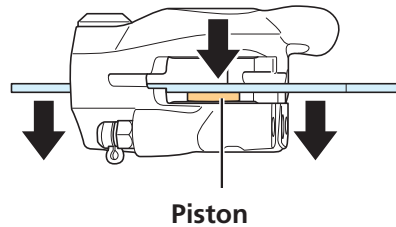

NOTICE

- Do not push the pistons with a sharp tool. Doing so may damage the pistons.

5. Set a brake pad presser spring in the new brake pads.

Since there are fins on the front and rear of the finned pads, set the pads as shown in the figure.

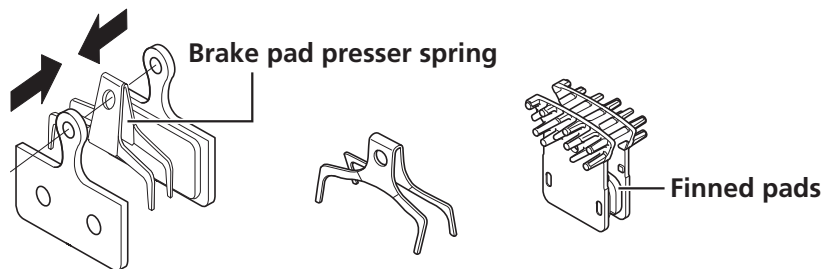

6. Install the brake pads.

- (1) Set the brake pads in the caliper.
- (2) Insert the pad axle.
- (3) Install the snap retainer.
- (4) Install the pad spacer (red).

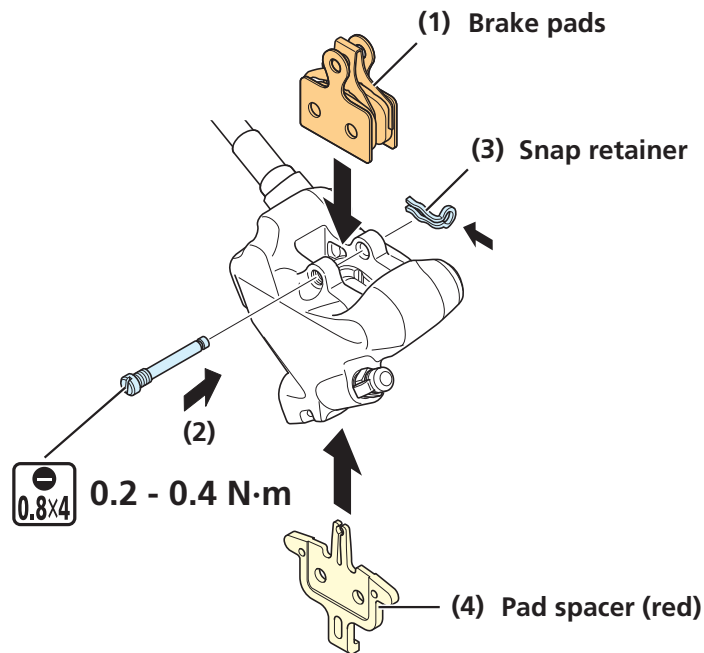

7. Depress the brake lever a few times and make sure that the lever operation becomes stiff.

8. Remove the pad spacer and install the wheel.

9. Check that the disc brake rotor does not interfere with the brake pads.

If there is interference, check if the wheel is installed correctly. If there is no problem with the installation position of the wheel, refer to "Installing the brake caliper" and adjust the position of the caliper.

SHIMANO genuine mineral oil replacement

It is recommended to change your oil when the oil in the reservoir tank becomes noticeably discolored.

Draining the mineral oil

Follow local county and/or state codes for disposal of used oil.

1. Position the bicycle as shown in the figure.

Install a bleed spacer (yellow) to the caliper and secure the bicycle with a stand, etc.

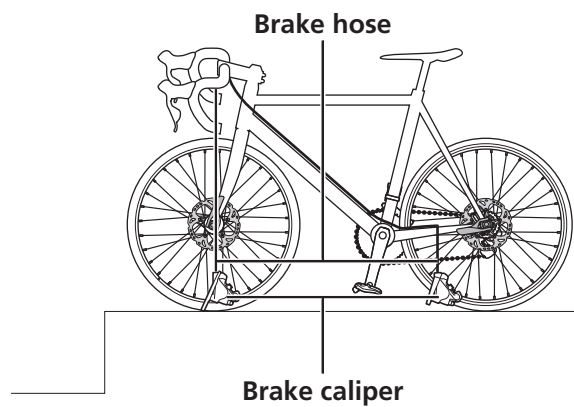

2. Turn over the bracket cover from the front side.



3. Set the lever in a position where the top surface of the bleed screw is parallel with the ground.

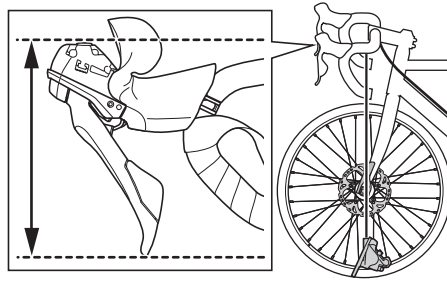

4. Remove the bleed screw and O-ring.

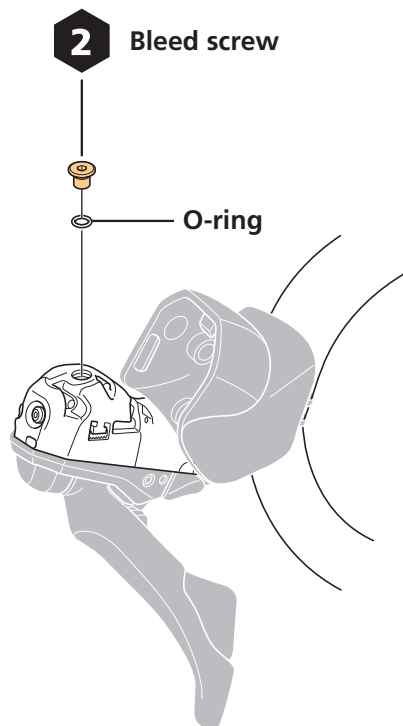

5. Install a bag and tube on the bleed nipple.

- (1) Place a 7 mm socket wrench in the position shown in the figure.
- (2) Connect the bag and attached tube to the bleed nipple.

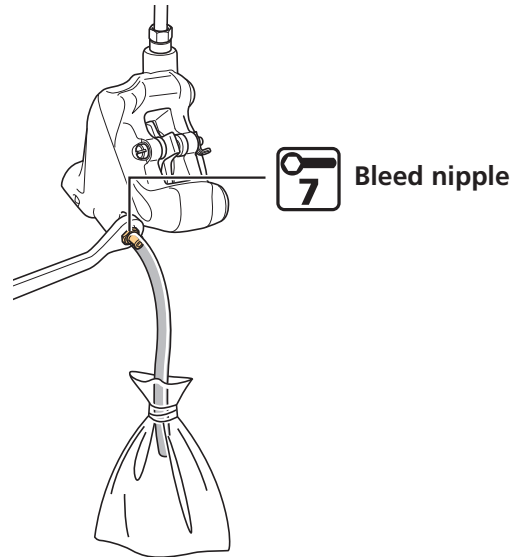

6. Loosen the bleed nipple.

The oil will begin to drain. Operating the brake lever while the oil drains will allow the oil to drain more easily.

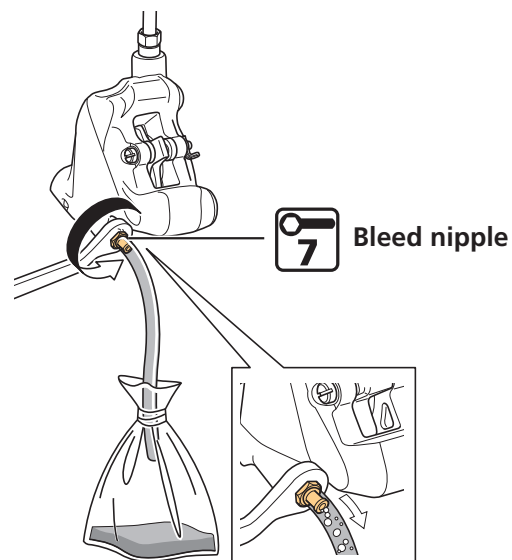

Adding mineral oil and bleeding air

When adding oil, use only SHIMANO genuine mineral oil.

1. Position the bicycle as shown in the figure.

Install a bleed spacer (yellow) to the caliper and secure the bicycle with a stand, etc.

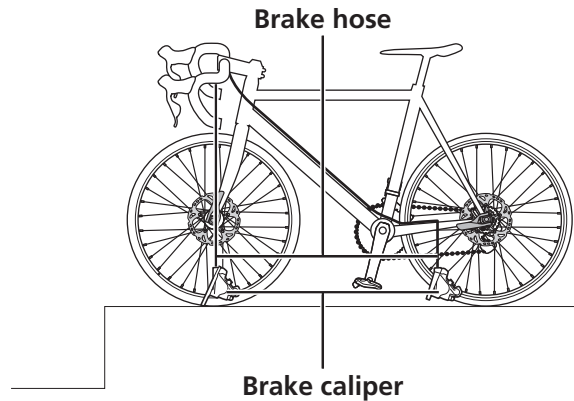

NOTICE

- When bleeding the air out of the caliper, you will need the SM-DISC (oil funnel and oil stopper).

2. Turn over the bracket cover from the front side.



3. Set the lever in a position where the top surface of the bleed screw is parallel with the ground.

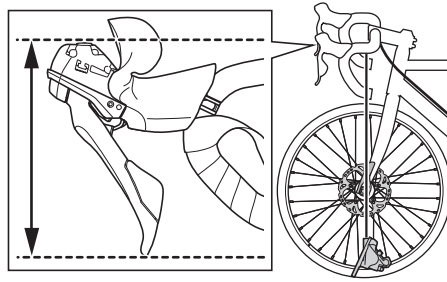

NOTICE

- When tilting, be careful not to forcibly pull on the brake hose or shifting cable.

4. Remove the bleed screw and O-ring.

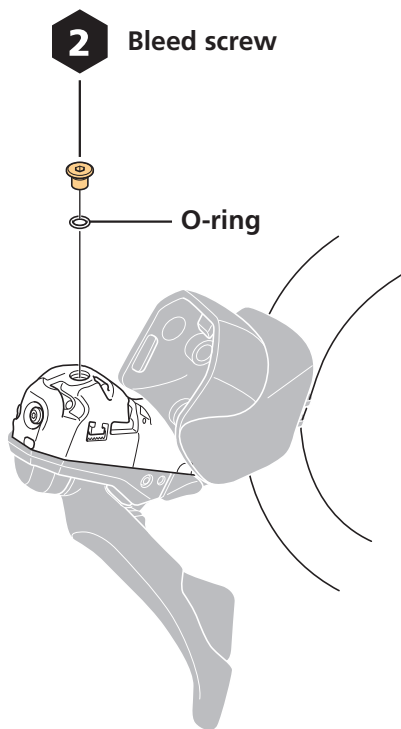

TECH TIPS

- Be careful not to drop the bleed screw and O-ring.

5. Install the funnel adapter to the oil funnel.

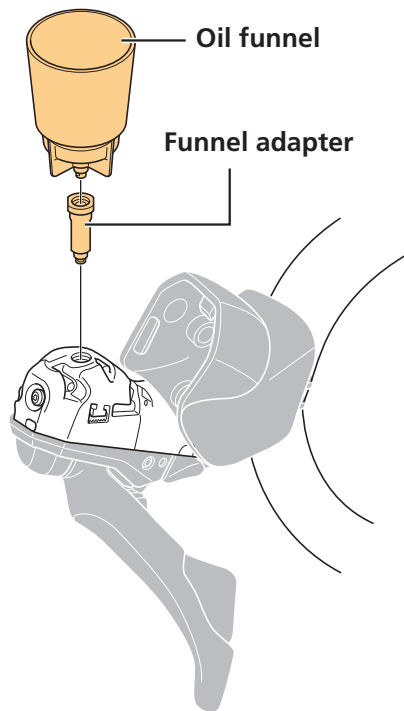

6. Install the oil funnel.

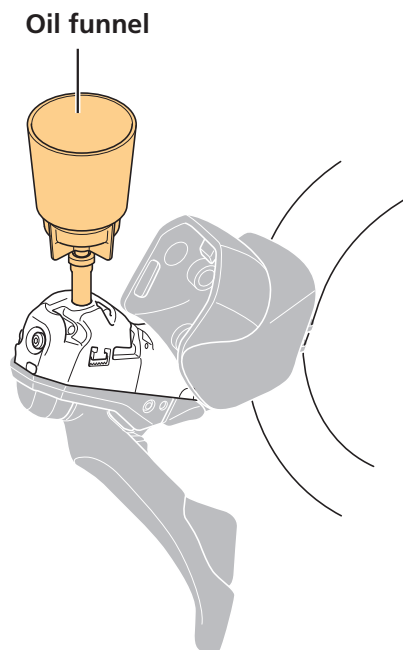

7. Set the lever in a position where the bracket surface indicated in the figure is parallel with the ground.

Perform adjustment by changing the angle of the handle, etc.

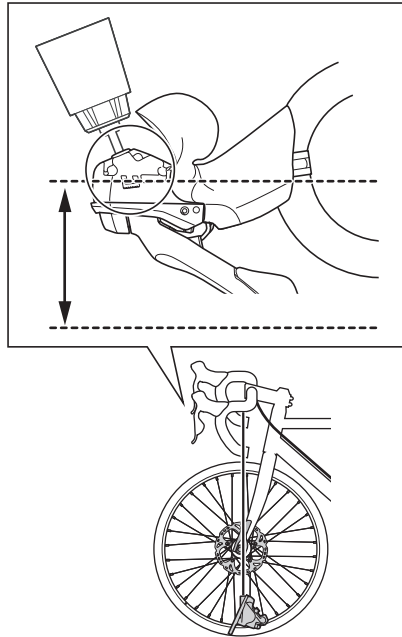

NOTICE

- When tilting, be careful not to forcibly pull on the brake hose or shifting cable.

8. Add the oil through the bleed nipple.

- (1) Place a 7 mm socket wrench in the position shown in the figure.
- (2) Fill a syringe with oil, and then connect the tube to the bleed nipple.
- (3) Fix the tube with a tube holder so that it does not come loose.
- (4) Loosen the bleed nipple by 1/8 of a turn.
- (5) Push the piston of the syringe to add the oil.
- (6) Oil will start to come out from the oil funnel. Continue adding the oil until there are no more air bubbles in the oil that is coming out.

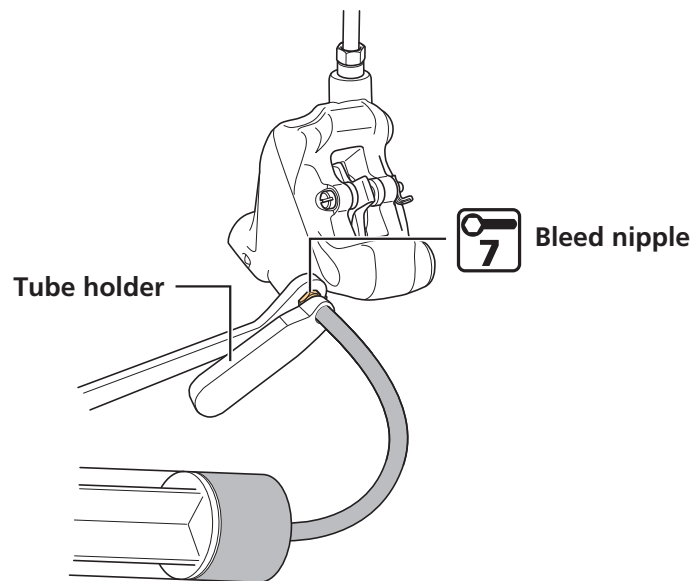

NOTICE

- Secure the brake caliper main body in a clip to prevent the tube from being disconnected accidentally.
- Do not depress and release the lever repeatedly. Doing so will lengthen the amount of time needed to bleed the air as it will cause air bubbles to remain inside the brake caliper, even if no bubbles appear. (If the lever was depressed and released repeatedly, drain out all of the oil and then add the oil again.)

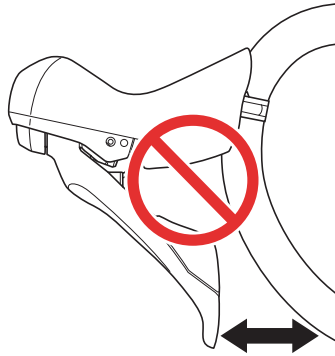

9. Once there are no more air bubbles mixed in with the oil, set the lever in the position where the bracket is at 45°, as shown in the figure.

Perform adjustment by changing the angle of the handle, etc.

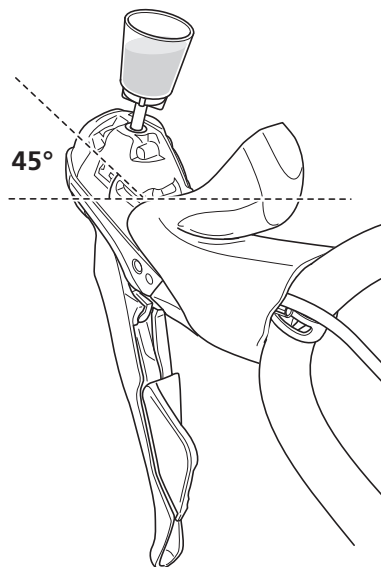

10. Fill the oil funnel with oil until there are no more air bubbles mixed in with the oil, and temporarily close the bleed nipple.

11. Remove the syringe.

Hold the tip of the syringe tube with a waste cloth, etc. so that the oil does not scatter.

12. Bleed the air.

Most of the air bubbles remaining inside the brake system can be bled by performing the following operation.

- (1) Place a 7 mm socket wrench in the position shown in the figure.
- (2) Connect the bag and attached tube to the bleed nipple.
- (3) Loosen the bleed nipple.
- (4) After waiting a moment, the oil and air bubbles will flow naturally from the bleed nipple into the tube.

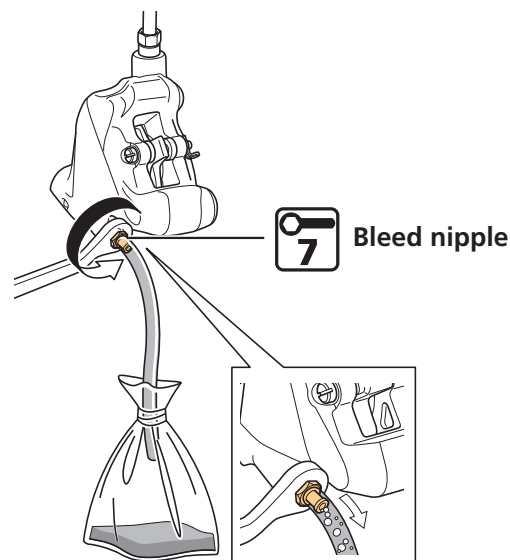

TECH TIPS

- It may be effective to shake the brake hose gently, to tap the bracket of the lever and caliper gently with a screwdriver, or to move the position of the calipers.

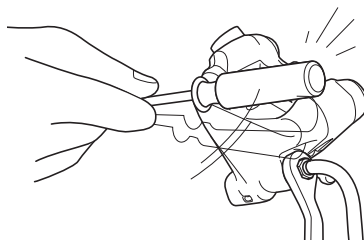

13. While bleeding the air, maintain the oil level by adding additional oil.

Add additional oil so that more air is not sucked in (air does not get inside) when the oil level inside the funnel drops.



14. Once no more air bubbles come out from the bleed nipple, temporarily tighten the bleed nipple.

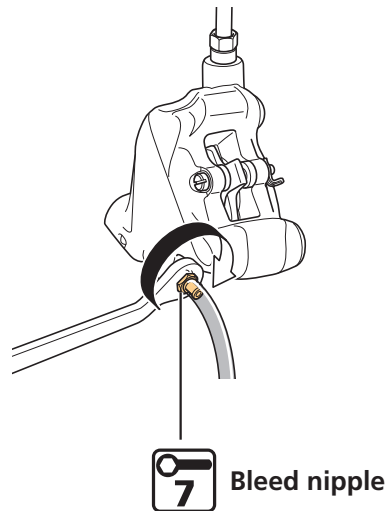

15. With the lever depressed, loosen and tighten the bleed nipple in rapid succession.

Loosen and tighten for approximately 0.5 seconds each time to release any air bubbles inside the caliper.

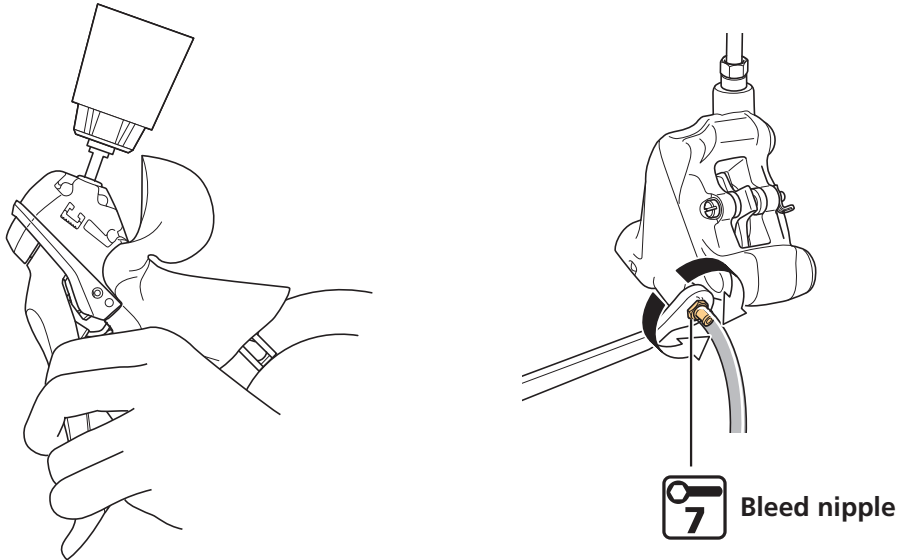

16. Repeat step 15 two to three times, and then tighten the bleed nipple.

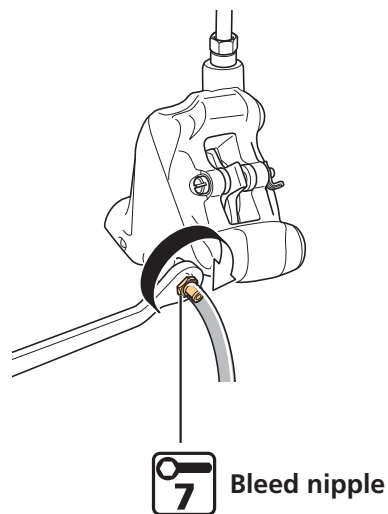

17. Set the lever in a position where the bracket surface indicated in the figure is parallel with the ground.

Perform adjustment by changing the angle of the handle, etc.

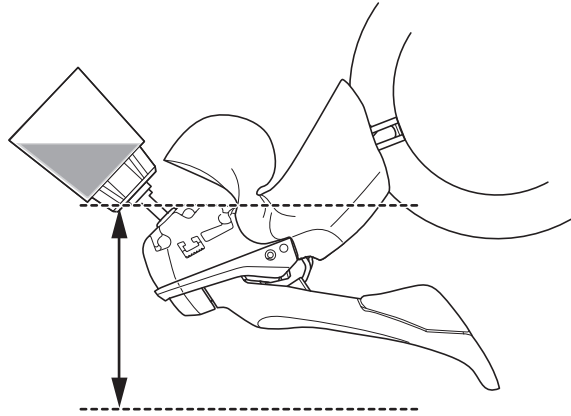

18. Operate the lever.

Slowly repeat until no more air bubbles appear.

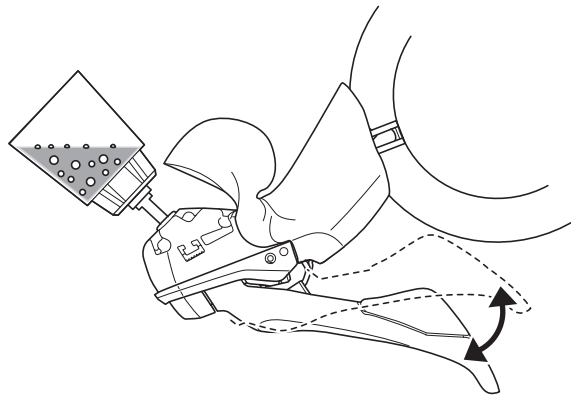

19. Set the lever in a position where the bracket surface indicated in the figure is at 45° to the ground.

Perform adjustment by changing the angle of the handle, etc.

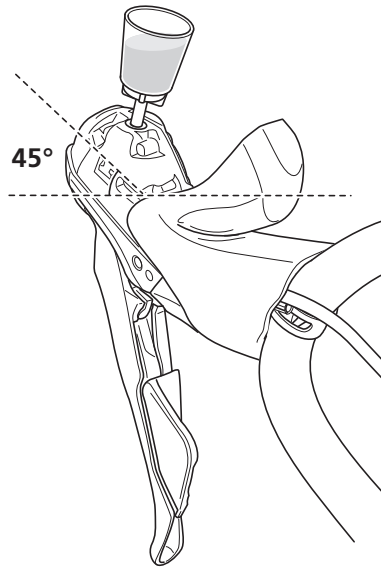

20. Operate the lever.

Air bubbles in the system will rise up through the port into the oil funnel. Slowly repeat until no more air bubbles appear.

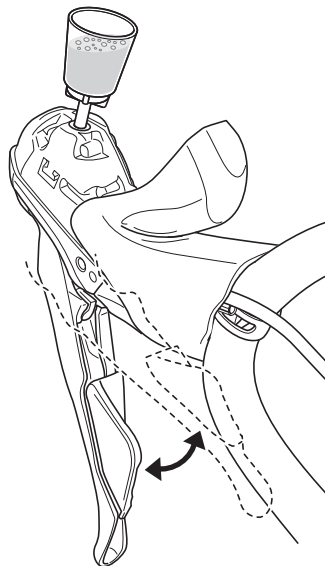

21. Check that the lever has become stiff.

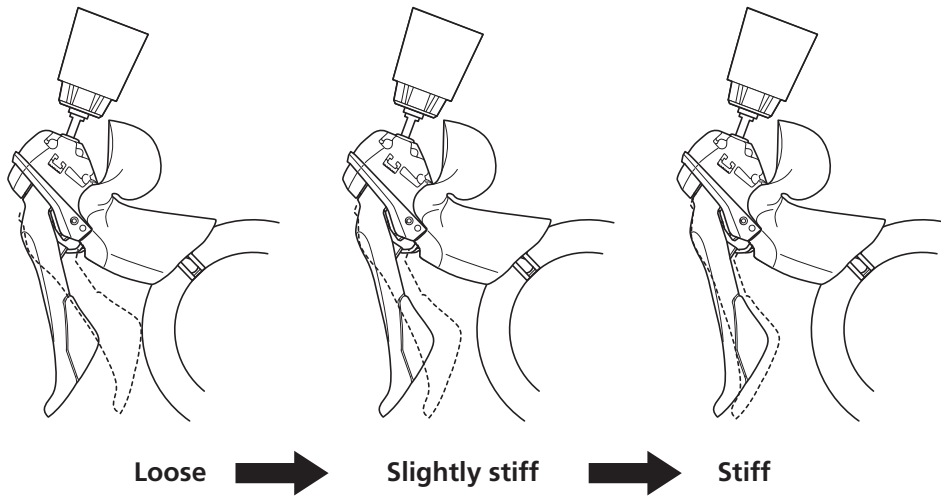

NOTICE

- If the lever does not become stiff, repeat the procedures from step 12.

22. Set the lever in a position where the top surface of the bleed screw is parallel with the ground.

Perform adjustment by changing the angle of the handle, etc.

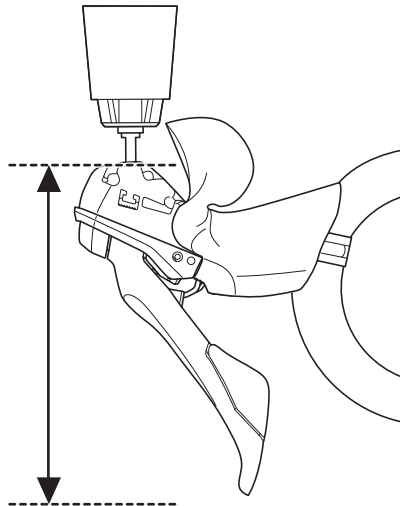

23. Plug the oil funnel with the oil stopper.

Make sure that the side of the oil stopper with the O-ring attached is facing downward.

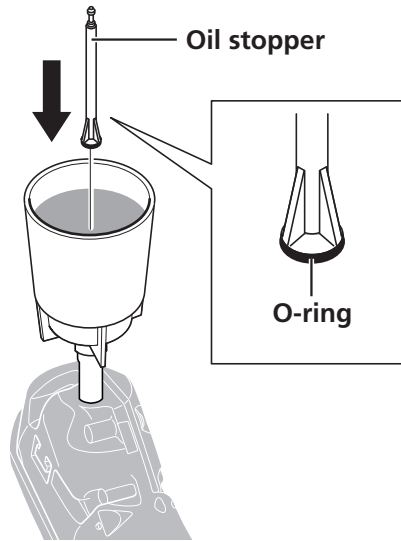

24. Remove the oil funnel.

Remove the oil funnel while it is still plugged by the oil stopper.

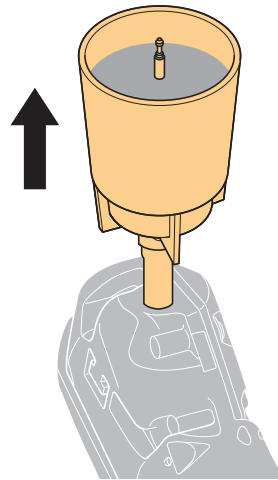

25. Tighten with a bleed screw to which an O-ring has been attached.

Tighten until oil flows out to make sure that no air bubbles remain inside the reservoir tank.

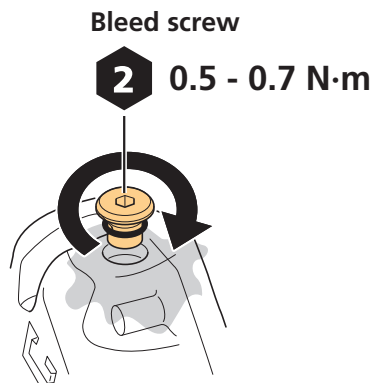

NOTICE

- Do not operate the lever. If operated, there is a risk that air bubbles may enter the cylinder.

26. Wipe away any oil that has overflowed.

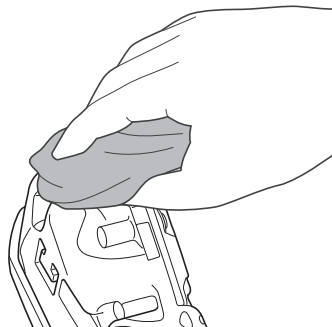

Replacing the brake hose

After replacing the brake hose, refer to "SHIMANO genuine mineral oil replacement" to replace the mineral oil and bleed the air from the system.

Checking and cutting the hose length

1. Route the brake hose into the final installation position.

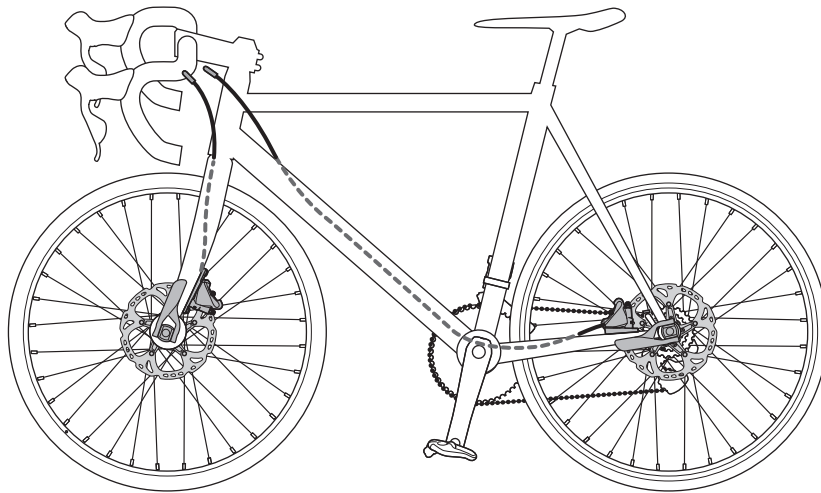

2. After determining the appropriate length, add a check mark on the brake hose.

Add marks to both the lever side and caliper side of the hose.

For the lever side

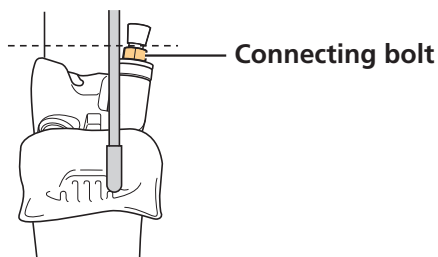

For the caliper side

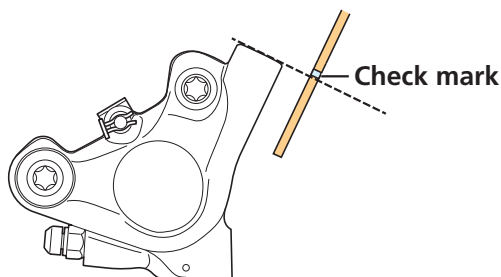

3. Cut the brake hose.

Refer to "Cutting the hose" in "Installing the brake hose."

For the lever side

1. Pass the connecting bolt with flange and olive over the brake hose.

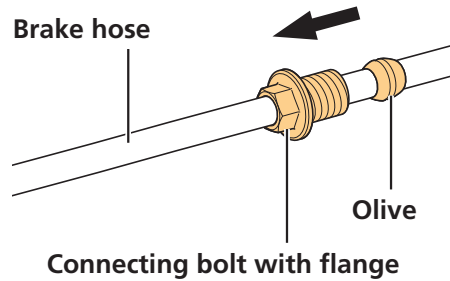

2. Check that the olive is in the position shown in the figure, and then apply grease to the threads of the connecting bolt and outer surface of the olive.

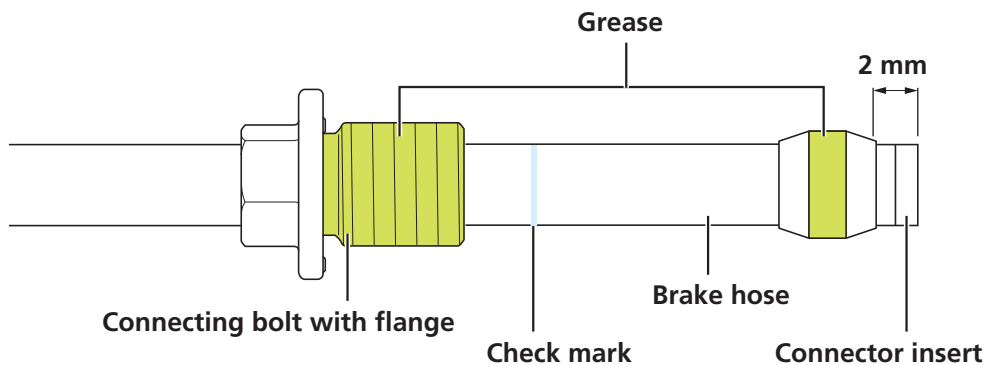

3. Install the brake hose in the lever.

Secure the lever to the handlebar or in a vise and insert the brake hose straight in.

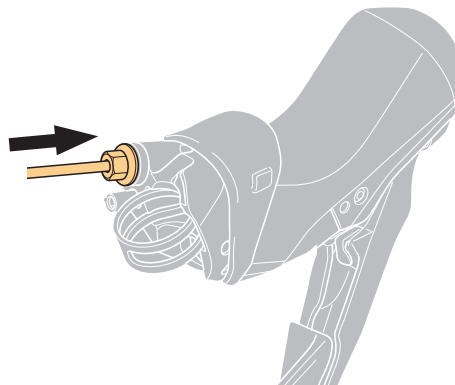

4. Tighten the connecting bolt with flange while pushing on the brake hose.

Make sure the brake hose is straight when pushing.

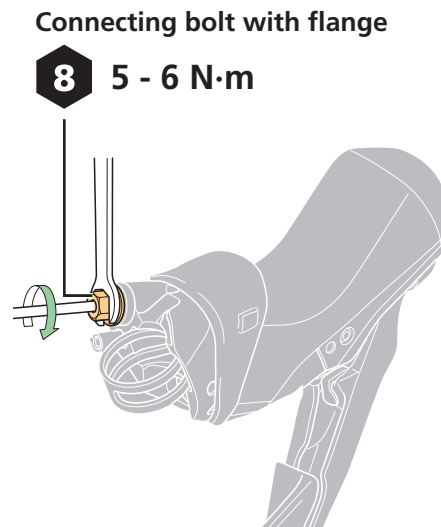

NOTICE

- When attaching to the handlebar, adjust the angle of the bracket by tilting the bracket from the handlebar so that you can turn the spanner. When doing so, take care not to damage the handlebar, etc.

5. Temporarily attach the brake hose to the handlebar using tape, etc.

For the caliper side

1. Pass the connecting bolt and olive over the brake hose.

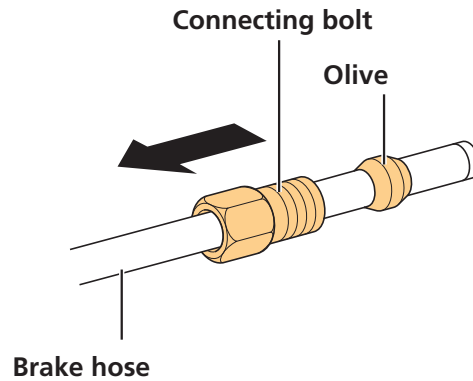

2. Check that the olive is in the position shown in the figure, and then apply grease to the threads of the connecting bolt and outer surface of the olive.

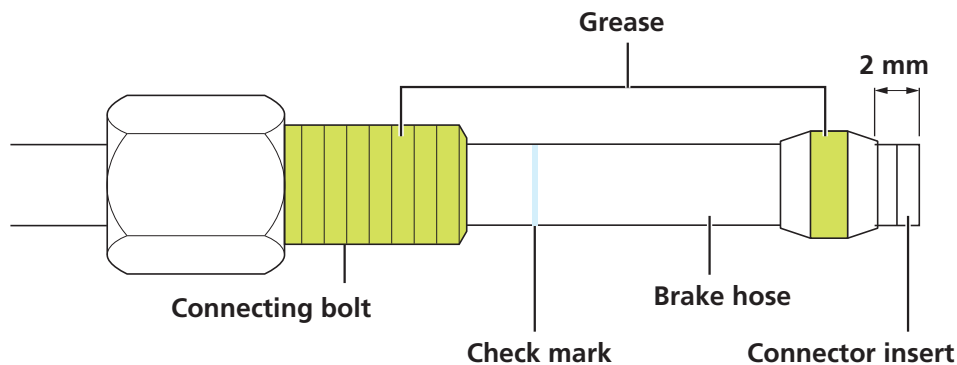

3. Install the brake hose in the caliper.

Insert the hose until the check marks added beforehand on the surface of the hose are covered.

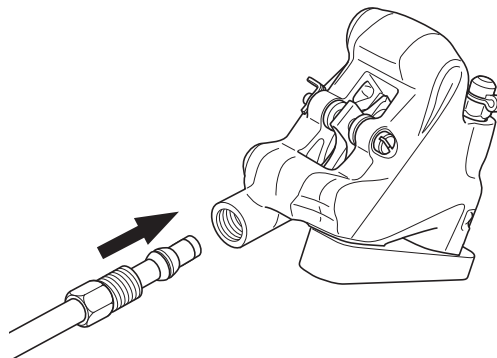

NOTICE

- Do not let the brake hose become twisted when installing it. Check that the caliper and lever are in the positions shown in the figure.

Left hand lever

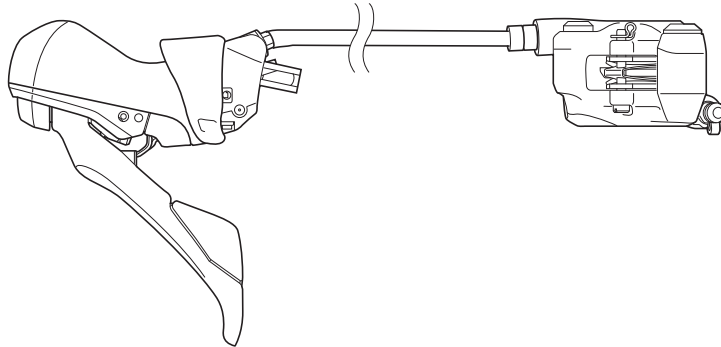

Right hand lever

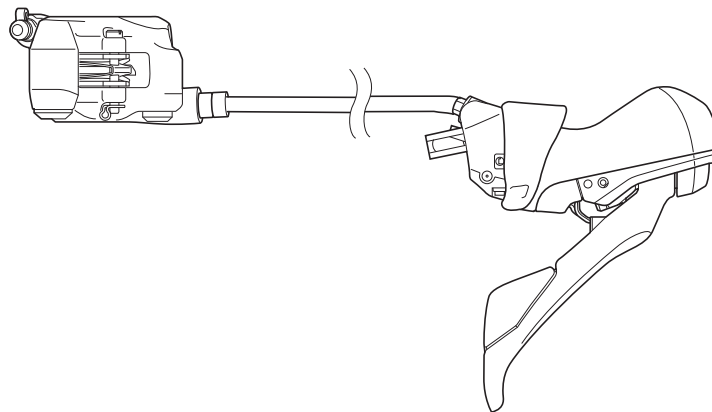

4. Tighten the connecting bolt while pushing on the brake hose.

Connecting bolt

8 5 - 7 N·m

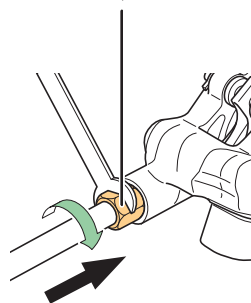

Adjustment when the pistons are not operating correctly

The caliper includes two pistons. Adjust the pistons with the following procedure if these pistons do not operate properly, if they protrude unevenly, or if the brake pads remain in contact with the disc brake rotor.

1. Remove the wheel from the frame.

2. Remove the brake pads from the caliper.

Remove the snap retainer, and then remove the pad axle.

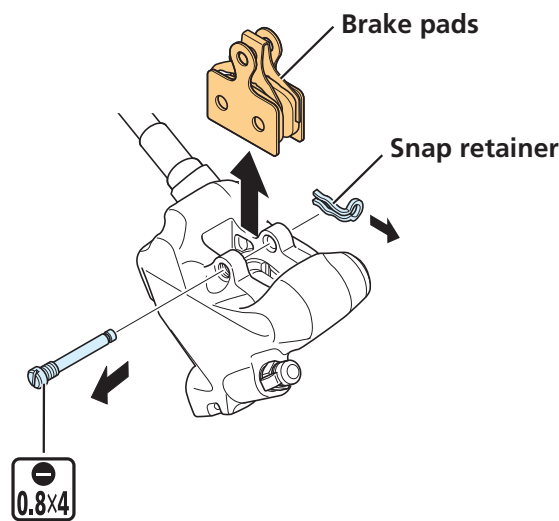

3. Clean the pistons and the surrounding area.

4. Push the pistons straight back as far as they will go.

Use a flat-shaped tool to push the pistons back while being careful not to twist them.

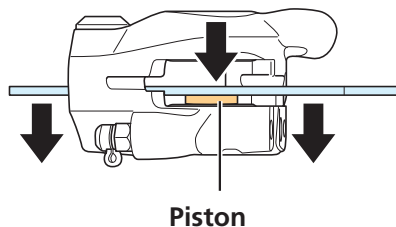

NOTICE

- Do not push the pistons with a sharp tool. Doing so may damage the pistons.

5. Install the brake pads and pad spacer (red) in the caliper.

6. Operate the lever through its full range of travel and depress it several more times so that the two pistons move to their initial positions.

7. Remove the pad spacer and install the wheel.

8. Check that the disc brake rotor does not interfere with the brake pads.

If there is interference, loosen the fixing bolt and adjust until there is no more interference.

Replacing the name plate

1. Perform a brake operation while performing a shift operation with the lever.

The screw is exposed.

2. Remove the screw, and replace the name plate.

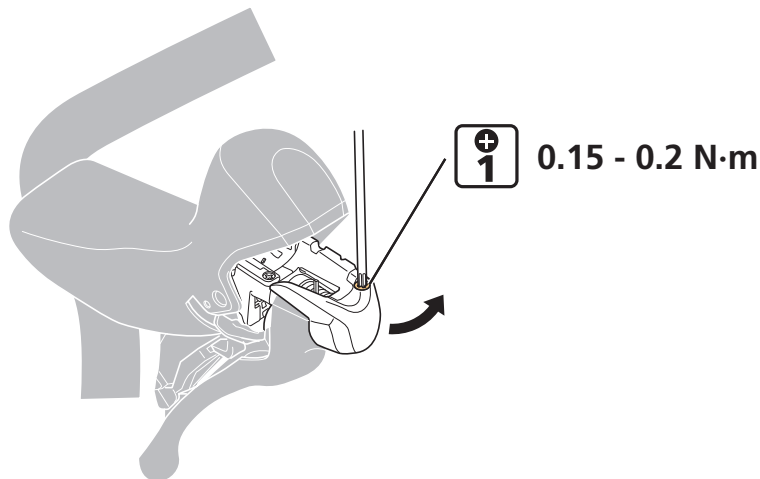

NOTICE

- As the screw is small, be careful not to drop it.

Replacing the bracket cover

1. Remove the bracket cover.

2. Install a new bracket cover.

Insert the protrusions on the bracket cover into the hollows in the bracket body when fitting on the bracket cover.

To install the bracket cover, remove the lever and brake hose from the frame, or remove the brake caliper from the frame, and then pass the bracket cover through from the caliper side.

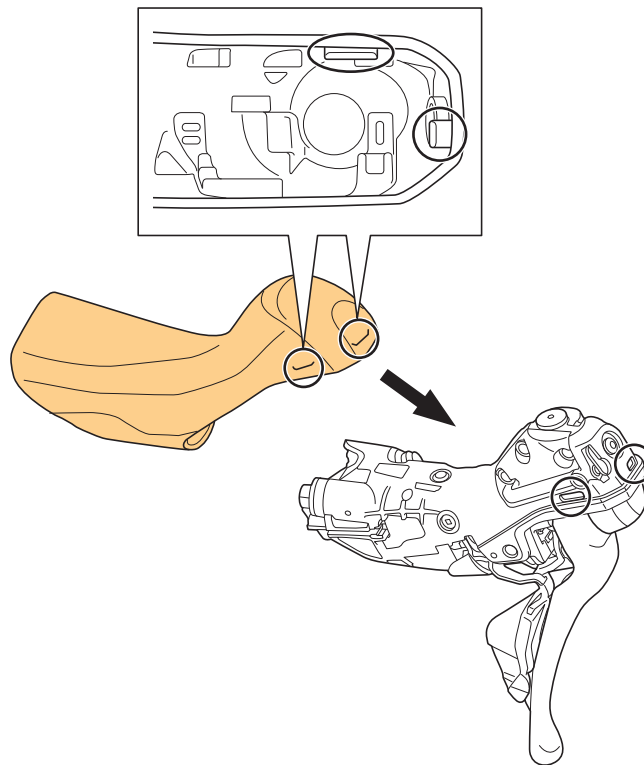

NOTICE

- The inside of the bracket cover has a mark indicating the left side or right side.
- Perform bleeding again after removing the brake hose.

TECH TIPS

- It is easier to perform installation if alcohol is applied to the inside of the bracket cover.

Replacing the main lever support

1. Operate the release lever two or more times, and then shift the main lever by two gears.

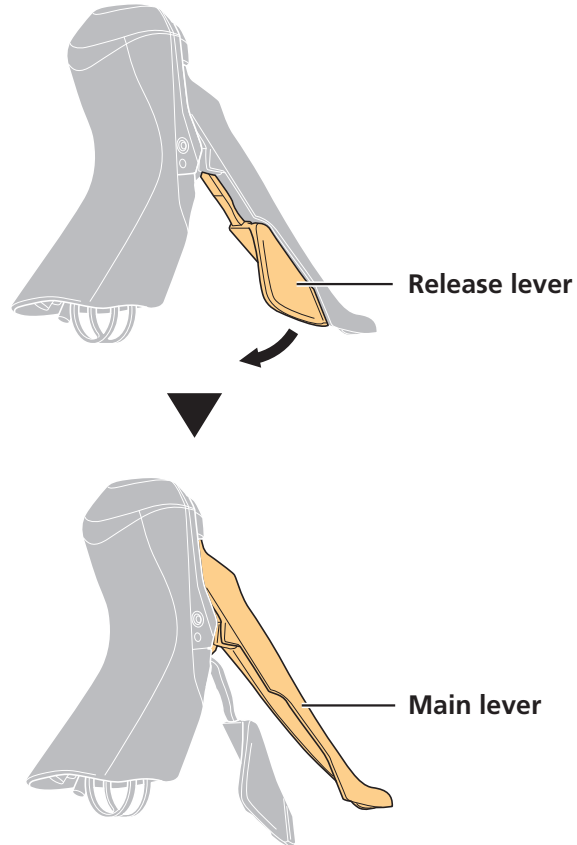

2. Hold the base of the main lever with your fingers, and return only the main lever to the original position.

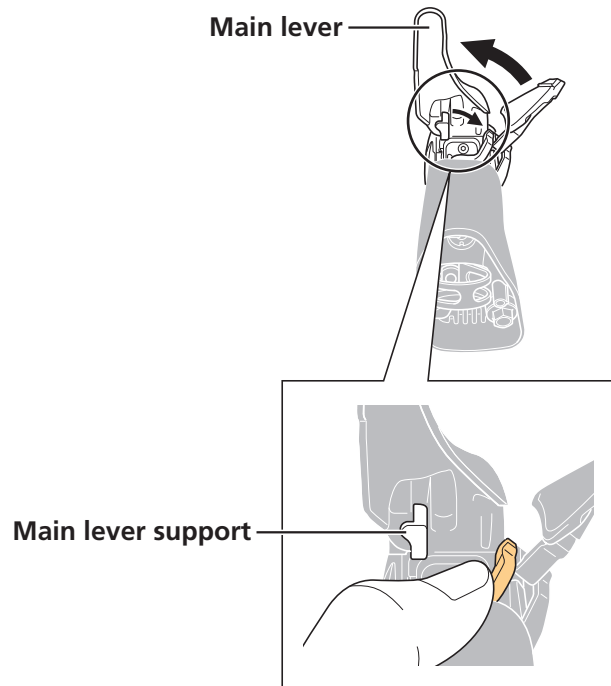

3. Remove the stopper.

Rotate the main lever support in the direction of the arrow with a slotted screwdriver or an equivalent tool.

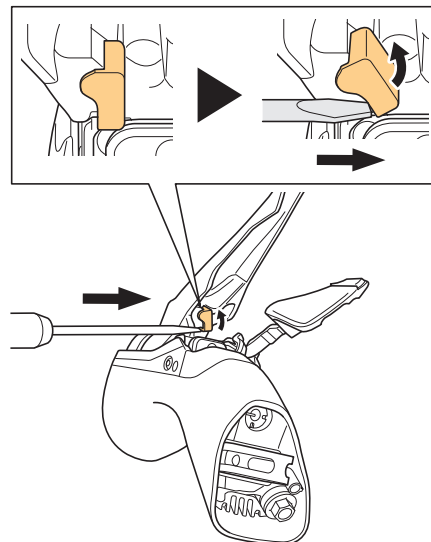

4. Pull out the main lever support.

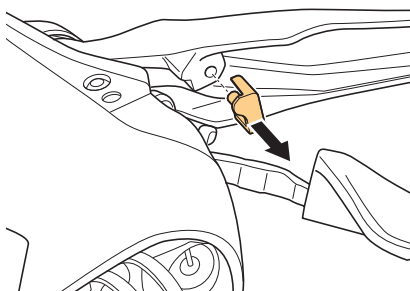

5. Insert a new main lever support.

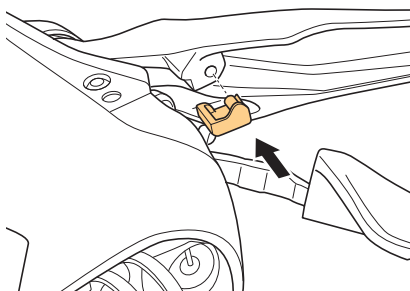

Replacing the cable cover

1. Turn over the bracket cover from the rear side.

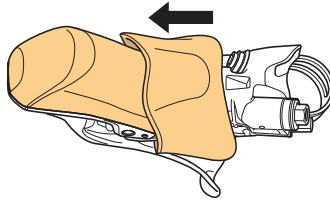

2. Remove the cable cover from the bracket.

Remove it using a screwdriver, etc.

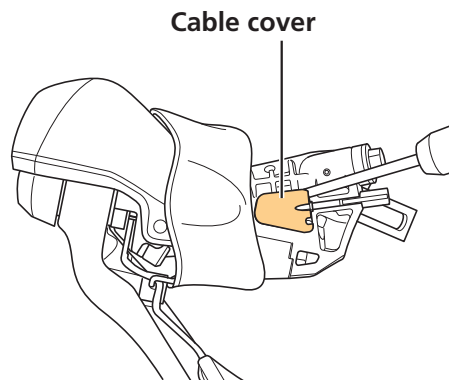

3. Insert a new cable cover into the hole of the bracket.

Before installation, make light folding marks on the cable cover.

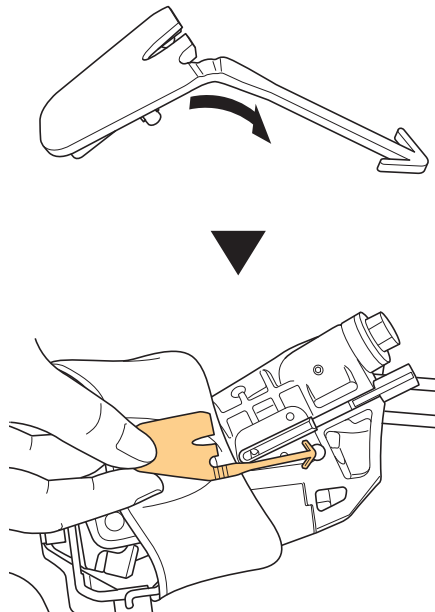

Pulling out a disconnected inner end (shifting cable)

If it is hard to pull out the inner end, follow the procedure below.

1. Remove the lever from the handle, and then remove the bracket cover.

TECH TIPS

- In order to maintain a smooth shifting condition, it is recommended that the inner cable is replaced together with the cable guide if it is disconnected.

2. Remove the unit cover.

Remove the screws located at the bottom of the bracket.

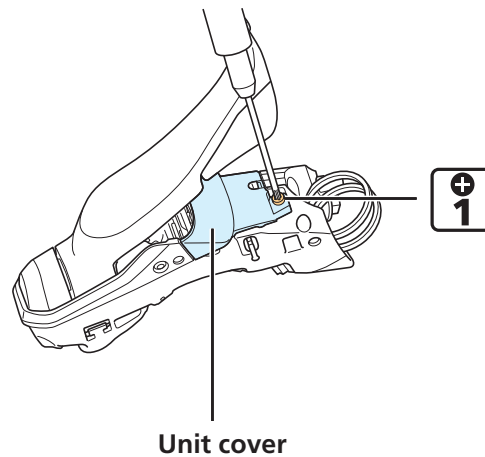

3. Pull out the inner end stayed on the cable hook of the winding body.

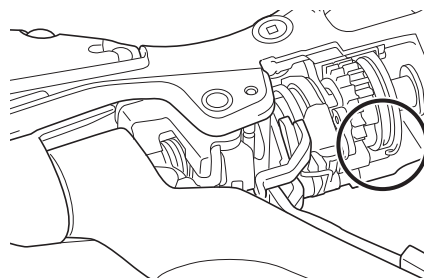

NOTICE

- Be careful not to touch the spring accidentally. Doing so could cause a malfunction

4. Install the unit cover.

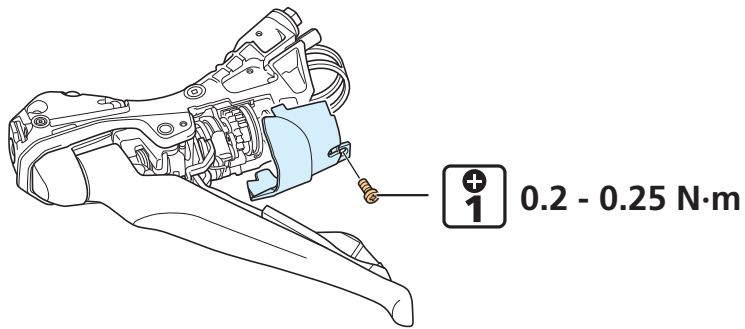

Replacing the SL cable guide

1. Turn over the bracket cover from the rear side.

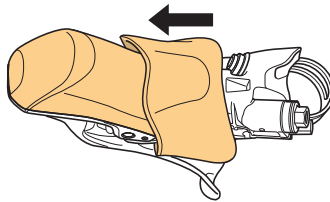

2. Open the cable cover.

Open it using a screwdriver, etc.

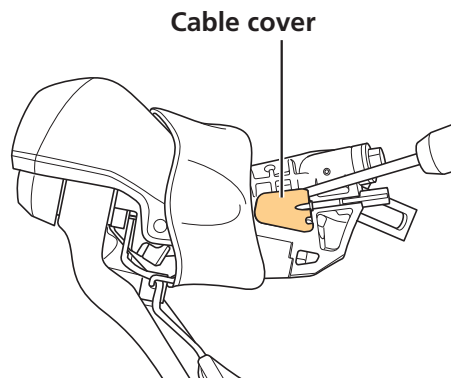

3. Pull out the SL cable guide.

Use a pointed tool to pry it out.

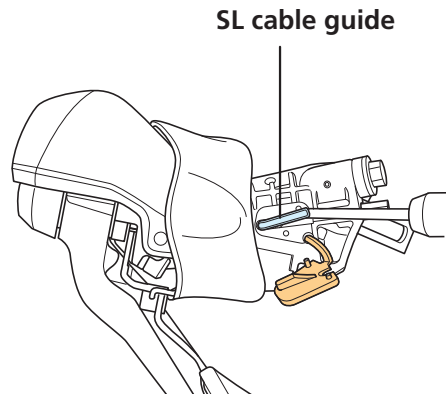

4. Push in the new SL cable guide with your hands.

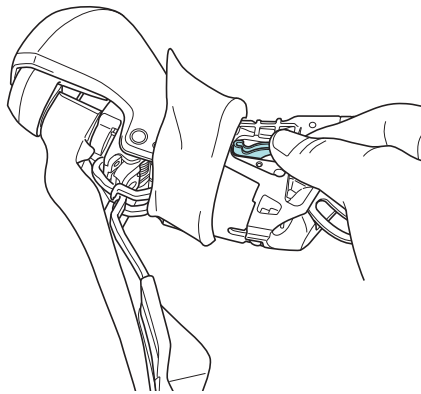

5. Close the cable cover.

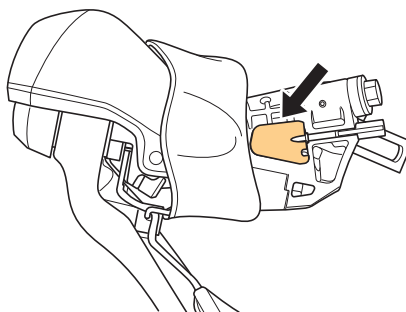

SHIMANO

SHIMANO NORTH AMERICA BICYCLE, INC.

One Holland, Irvine, California 92618, U.S.A. Phone: +1-949-951-5003

SHIMANO EUROPE B.V.

High Tech Campus 92, 5656 AG Eindhoven, The Netherlands Phone: +31-402-612222

SHIMANO INC.

3-77 Oimatsu-cho, Sakai-ku, Sakai City, Osaka 590-8577, Japan

Please note: specifications are subject to change for improvement without notice. (English)

© Feb. 2019 by SHIMANO INC. ITP