

Dealer's Manual

Hub roller brake

BR-C6060-F

BR-C6000

BR-C3000

BR-C3010

BR-IM81

BR-IM86

BR-IM31

BR-IM35

BL-C6000





BL-C6010

BL-IM60-A

CONTENTS

IMPORTANT NOTICE	4
TO ENSURE SAFETY	5
INSTALLATION	10
List of tools to be used.....	10
Installation of the lever	11
Installing the INTER M brake to the hub body.....	11
Installation of the hub to the frame.....	12
Installation of the brake cable	16
ADJUSTMENT	23
Adjusting the brake cable	23
MAINTENANCE	26
Applying grease	26

List of DM-compatible models

Parts / Series	INTER-8	INTER-7	INTER-5	INTER-3
 Internal hub gear	SG-C6010-8R SG-C6000-8R	SG-C3000-7R	SG-5R30 SG-5R35	SG-3R40
 Brake lever	BL-C6010 BL-IM60-A		BL-IM45 BL-IM65 BL-IM60 BL-C6000	
 Hub roller brake	BR-C3000 BR-C3010 BR-C6000 BR-C6060-F		BR-IM31 BR-IM35 BR-IM81 BR-IM86	
Brake cable				

IMPORTANT NOTICE

- **This dealer's manual is intended primarily for use by professional bicycle mechanics.**

Users who are not professionally trained for bicycle assembly should not attempt to install the components themselves using the dealer's manuals.

If any part of the information on the manual is unclear to you, do not proceed with the installation. Instead, contact your place of purchase or a local bicycle dealer for their assistance.

- Make sure to read all instruction manuals included with the product.
- Do not disassemble or modify the product other than as stated in the information contained in this dealer's manual.
- All dealer's manuals and instruction manuals can be viewed on-line on our website (<https://si.shimano.com>).
- For consumers who do not have easy access to the internet, please contact a SHIMANO distributor or any of the SHIMANO offices to obtain a hardcopy of the User's Manual.
- Please observe the appropriate rules and regulations of the country, state or region in which you conduct your business as a dealer.

For safety, be sure to read this dealer's manual thoroughly before use, and follow it for correct use.

The following instructions must be observed at all times in order to prevent personal injury and physical damage to equipment and surroundings. The instructions are classified according to the degree of danger or damage which may occur if the product is used incorrectly.

 **DANGER**

Failure to follow the instructions will result in death or serious injury.

 **WARNING**

Failure to follow the instructions could result in death or serious injury.

 **CAUTION**

Failure to follow the instructions could cause personal injury or physical damage to equipment and surroundings.

TO ENSURE SAFETY

⚠ WARNING

- **When installing components, be sure to follow the instructions that are given in the instruction manuals.**

It is recommended that you use only genuine SHIMANO parts. If parts such as bolts and nuts become loose or damaged, the bicycle may suddenly fall over, which may cause serious injury.

In addition, if adjustments are not carried out correctly, problems may occur, and the bicycle may suddenly fall over, which may cause serious injury.

-  Be sure to wear safety glasses or goggles to protect your eyes while performing maintenance tasks such as replacing parts.
- After reading the dealer's manual thoroughly, keep it in a safe place for later reference.

Be sure to also inform users of the following:

- Each bicycle's brake system may handle slightly differently depending on the model. Therefore, be sure to learn the proper braking technique (including brake lever pressure and bicycle control characteristics) and operation of your bicycle. Improper use of your bicycle's brake system may result in loss of control or an accident, which could also lead to severe injury. For proper operation, consult your professional bicycle dealer or the bicycle's owner's manual. It is also important to practice riding and your braking technique, etc.
- You need to use the SHIMANO front INTER M brake body and the hub as a set (excluding BR-C6060-F). The hub of the SHIMANO front INTER M brake has a built-in power modulator. This system controls the braking force so that excessive force is not applied if the braking force reaches the specified value. If the front brake is applied too strongly in the case that the hub is not equipped with the power modulator or the hub and brake are equipped with power modulators but the overall mass does not meet the recommended mass, the wheel may lock and the bicycle may fall forward, and serious injury may result.
- The range of overall allowable mass (bicycle + rider + luggage) of the BR-C6060-F power modulator.

Outer diameter of tire (mm)	Range of overall allowable mass (kg)
660 - 712	100 - 130

If the overall mass is out of the allowed range, the controlled braking force may be too strong or too weak.

Use the BR-C6060-F power modulator within its range of overall allowable mass.

- Never tighten the inner cable fixing bolt with it attached to your bicycle. Doing so may cause the inner cable fixing bolt to detach.

< Front >

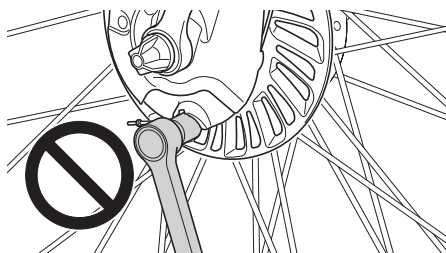

< Rear >

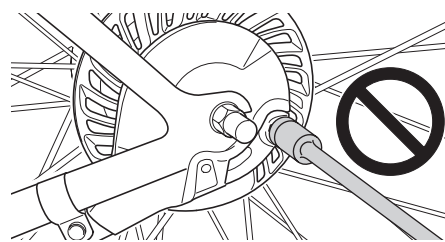

- If using the hub roller brakes in combination with a suspension fork, care must be taken when selecting the suspension fork to use. Please consult with the shop or the bicycle manufacturer. If an incorrect type of suspension fork is selected, it could prevent the suspension fork from functioning properly because of overheating during braking or lack of strength in the fork, which could result in an accident.

- The brake levers are equipped with a mode switching mechanism to make them compatible with cantilever brakes and roller brakes or V-BRAKE brakes with power modulator. (BL-C6010 / BL-IM60-A is compatible with roller brakes or V-BRAKE brakes with power modulator. Please note that it is not compatible with cantilever brakes.)

If the incorrect mode is selected it may cause either excessive or insufficient braking force to occur, which could result in dangerous accidents. Be sure to select the mode in accordance with the instructions given in the table below.

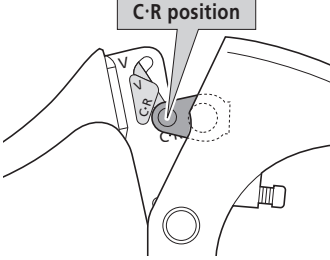
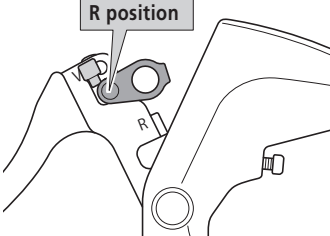
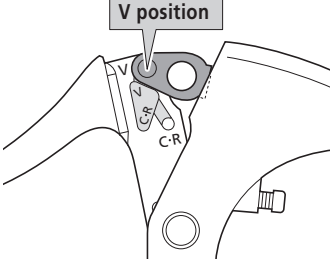
Mode position		Applicable brake
<p>C : Mode position for compatibility with cantilever brakes</p> <p>R : Mode position for compatibility with roller brakes</p>		<ul style="list-style-type: none"> • Cantilever brakes • Roller brakes
<p>For BL-C6010 / BL-IM60-A</p> <p>R : Mode position for compatibility with roller brakes</p>		<ul style="list-style-type: none"> • Roller brakes
<p>V : Mode position for compatibility with V-BRAKE brakes with power modulator</p>		<ul style="list-style-type: none"> • V-BRAKE brakes with power modulator

Use the brake levers with mode switching mechanism in the combinations given above.

- When installing components, be sure to follow the instructions that are given in the instruction manuals. It is recommended that you use only genuine SHIMANO parts. If parts such as bolts and nuts become loose or damaged, the bicycle may suddenly fall over, which may cause serious injury.
- Always make sure that the front and rear brakes are working correctly before you ride the bicycle.
- If the road surface is wet, the tires will skid more easily. If the tires skid, you may fall off the bicycle. To avoid this, reduce your speed and apply the brakes early and gently.
- Check that the wheels are fastened securely before riding the bicycle. If the wheels are loose in any way, they may come off the bicycle and cause serious injury.
- After reading the dealer's manual thoroughly, keep it in a safe place for later reference.

For Installation to the Bicycle, and Maintenance:

- When securing the brake arm to the frame, be sure to use a brake arm clip that matches the size of the chainstay, and securely tighten them with the clip screw and clip nut to the specified tightening torque.
Use a lock nut with a nylon insert (self-locking nut) for the clip nut. It is recommended that standard SHIMANO parts be used for the clip screw, clip nut and brake arm clip.
If the clip nut comes off the brake arm, or if the clip screw or brake arm clip becomes damaged, the brake arm may rotate on the chainstay and cause the handlebars to jerk suddenly, or the bicycle wheel may lock and the bicycle may fall over, causing serious injury.
- Depending on the product, the tire diameter of the compatible wheel may differ. Be sure to check the compatible size.
If an incompatible size is used, the wheels may lock and you may lose balance and fall off the bicycle.

⚠ CAUTION

Be sure to also inform users of the following:

- If any of the following occur while using the brakes, stop riding immediately and ask the place of purchase to carry out inspection and repairs.
 - 1) If an abnormal noise is heard when the brakes are applied
 - 2) If the braking force is abnormally strong
 - 3) If the braking force is abnormally weak
 If 1) and 2) occur, the cause might be a lack of brake grease, so ask the place of purchase to grease the mechanism with special roller brake grease.
 If 2) or 3) occurs when using BR-C6060-F, the power modulator may be malfunctioning. Have it inspected/repared at the place of purchase.
- If the brake is used frequently, the area around the brake may become hot. Do not touch the area around the brake for at least 30 minutes after you finish riding the bicycle.

Area around the brake



- Avoid continuous application of the brakes when riding down long slopes, as this will cause the internal brake parts of the SHIMANO INTER M brake system to become very hot, and this may weaken braking performance. It may also cause a reduction in the amount of brake grease inside the brake, and this can lead to problems such as abnormally sudden braking.
- The front INTER M brake system should only be installed to the left side of a bicycle which is 26 inch" or larger. If it is used on a bicycle which is smaller than 26 inch", the braking force may be too great, which could cause accidents.
- In order to get the best performance from the SHIMANO front INTER M brake, be sure to use SHIMANO brake cables and brake levers as a set. (<https://productinfo.shimano.com/lineupchart.html>) (The amount of movement of the inner cable must be: 21.5 mm (when using BL-C6010) / 16.5 mm (when using BL-C6000 / BL-IM60 / BL-IM65 / BL-IM45) or more when the brake lever is pressed. If it is less than 21.5 mm / 16.5 mm, braking performance will suffer, and the brakes may fail to work.)
- If the brake cable becomes rusted, braking performance will suffer. If this happens, replace the brake cable with a genuine SHIMANO brake cable and re-check the braking performance.
- The brake unit and front hub unit should never be disassembled. If they are disassembled, they will no longer work properly.
- For BR-C6060-F, the power modulator is built into the brake body so a power modulator is not needed in the hub body. However, the special front fork is needed to install it.

NOTICE

- Use a wheel with 3x or 4x spoke lacing. Cannot be used with wheels with radial lacing. Otherwise, the spokes or the wheel may be damaged, or noise may occur when braking.
- The INTER M brake is different from conventional band brakes in that the inside of the brake drum is filled with grease, causing the turning of the tire to be slightly heavier than usual. (Particularly in cold weather.)
- If you apply the front INTER M brake strongly while the bicycle is stopped and then shake the wheel, you will notice that there is a small amount of gap in the brakes. This is normal, and will not cause any problems at all while riding.

TO ENSURE SAFETY

- To check the amount of looseness in the head parts, grasp the middle of the handlebar and one of the front forks as shown in the illustration, and then move the head parts back and forth in the directions indicated by the arrows.
Moreover, because the brakes give a small amount of gap if you apply the brakes fully and shake the wheel as described above, this will make it more difficult to check the looseness in the head parts.

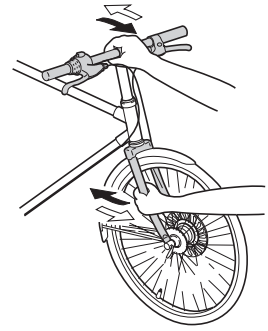

- Products are not guaranteed against natural wear and deterioration from normal use and aging.
- For maximum performance we highly recommend SHIMANO lubricants and maintenance products.

The actual product may differ from the illustration because this manual is intended chiefly to explain the procedures for using the product.

INSTALLATION





INSTALLATION

► List of tools to be used

INSTALLATION

■ List of tools to be used

The following tools are needed for installation, adjustment, and maintenance purposes.

Tool		Tool		Tool	
	Adjustable wrench		17 mm spanner		Screwdriver[#1]
	10 mm spanner		5 mm hexagon wrench		

Mode switching

1

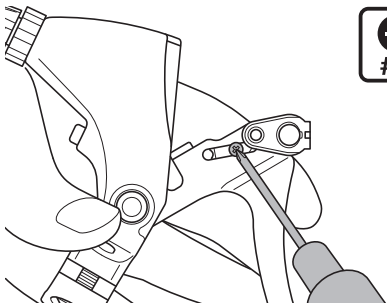



Use the screwdriver[#1] to loosen the screw.

2

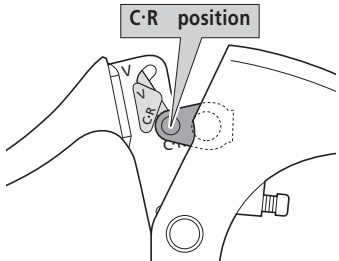

C-R position

Align the mode position with the C-R position.

INSTALLATION

► Installation of the lever

■ Installation of the lever

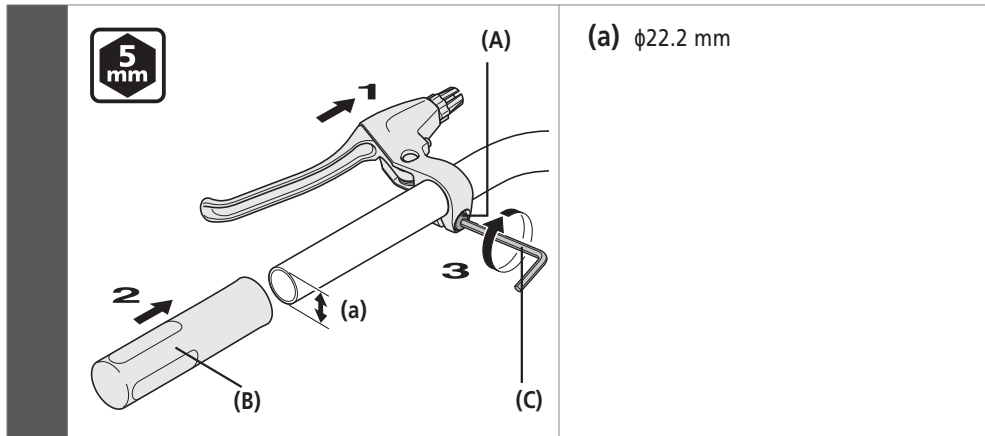

- (A) Clamp bolt
- (B) Grip
- (C) 5 mm hexagon wrench

Tightening torque

5 mm	6 - 8 N·m
------	-----------

■ Installing the INTER M brake to the hub body

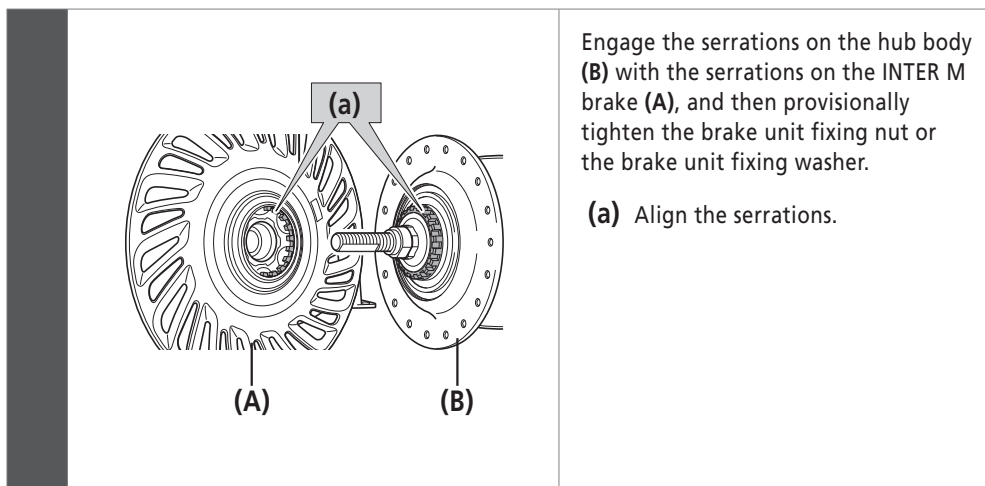

- (A) INTER M brake
- (B) Hub body



TECH TIPS

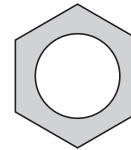

Brake unit fixing nut

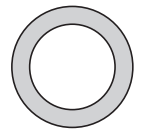

Brake unit fixing washer

■ Installation of the hub to the frame

Rear side

The hub installation is an example. Also refer to the manual for the hub.

1

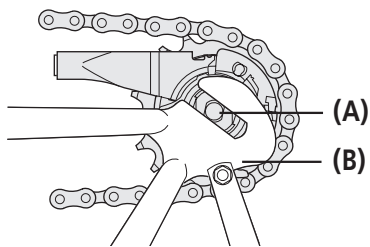

Mount the chain on the sprocket, and then set the hub axle (A) into the dropouts (B).

- (A) Hub axle
- (B) Dropouts

2

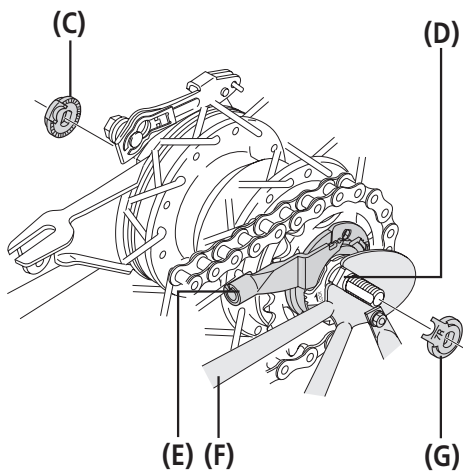

Place the non-turn washers onto the right side and left side of the hub axle.

At this time, turn the cassette joint (E) so that the projecting parts of the non-turn washers fit into the grooves of the dropouts (D). If this is done, the cassette joint can be installed so that it is almost parallel to the chainstay (F).

- (C) Non-turn washer (for left side)
- (D) Grooves of the dropouts
- (E) Cassette joint
- (F) Chainstay
- (G) Non-turn washer (for right side)

NOTICE

When installing a part such as a mudguard stay to the hub axle, install in the order shown in the illustration below.

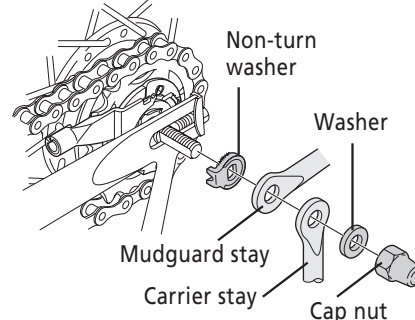

Dropouts	Non-turn washer		Size
	Mark/Color		
	Right	Left	
Standard	5R/Yellow	5L/Brown	$\theta \leq 20^\circ$
	7R/Black	7L/Gray	$20^\circ \leq \theta \leq 38^\circ$
Reversed	6R/Silver	6L/White	$\theta = 0^\circ$
Reversed (full chain case)	5R/Yellow	5L/Brown	$\theta = 0^\circ$
Vertical	8R/Blue	8L/Green	$\theta = 60^\circ - 90^\circ$

Note: vertical: excluding the coaster specifications

TECH TIPS

- Use whichever non-turn washers match the shape of the dropouts. Different non-turn washers are used at the left and right sides.
- The projecting parts should be on the dropouts side.
- Install the non-turn washers so that the projecting parts is securely in the dropouts grooves on either side of the hub axle.



INSTALLATION

► Installation of the hub to the frame

3

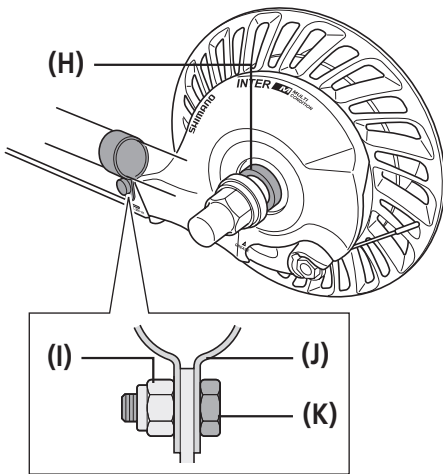

Attach the brake arm of the INTER M brake to the chainstay with the brake arm clip (J).

Then temporarily fix the clip screw (K) and clip nut (I) by lightly tightening them.

Check that the brake unit is firmly secured to the hub body with the brake unit fixing nut or brake unit fixing washer (H).

- (H) Brake unit fixing nut/Brake unit fixing washer
- (I) Clip nut
- (J) Brake arm clip
- (K) Clip screw (M6×16 mm)

NOTICE

If the hub nuts are cap nuts, use a frame with dropouts that are at least 7 mm thick.

4

Pull the wheel towards the rear to adjust the chain tension and align the wheel with the frame center.

5

Temporarily tighten the hub nut strongly.

6

Slightly loosen the hub nut.
Fully tighten the brake unit fixing nut.

Tightening torque



20 - 25 N·m

7

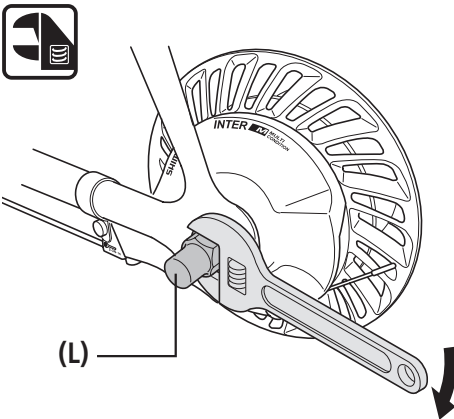

Take up the slack in the chain and secure the wheel to the frame with the hub nut (L).

- (L) Hub nut

Tightening torque



30 - 45 N·m

NOTICE

Check that the wheel is fixed securely to the frame with the hub nuts.

INSTALLATION

▶▶ Installation of the hub to the frame

8

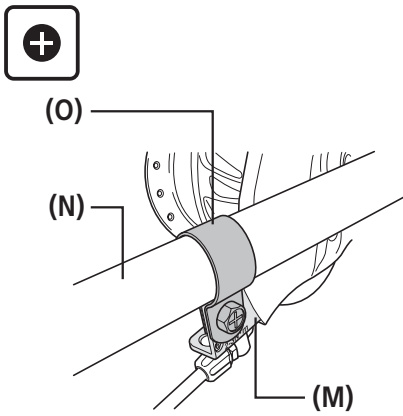

Fix the brake arm (M) securely to the chainstay (N) with the brake arm clip (O).

Check that the brake arm is securely fastened to the chainstay by the brake arm clip.

If it is not installed correctly, braking performance will suffer.

- (M) Brake arm
- (N) Chainstay
- (O) Brake arm clip

Tightening torque



2 - 3 N·m

NOTICE

If excessive force is applied to the brake arm to secure it, the wheel will make noise and become difficult to turn. Make sure that you don't apply excessive force when installing.



TECH TIPS

- When installing the arm clip, securely tighten the clip bolt while holding the clip nut with a 10 mm spanner.
- After installing the brake arm clip, check that the clip bolt protrudes about 2 - 3 mm (4 mm for BR-IM31/35) from the surface of the clip nut.

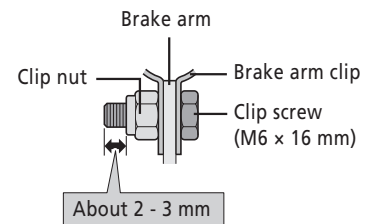

Front side

<For quick release type>

1

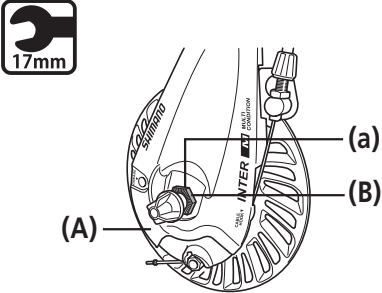

Check that the front brake unit (A) is firmly secured to the hub with the brake unit fixing nut (B).

(a) With notches (The side with notches is the front.)

- (A) Brake unit
- (B) Brake unit fixing nut

Tightening torque	
	15 - 20 N·m

2

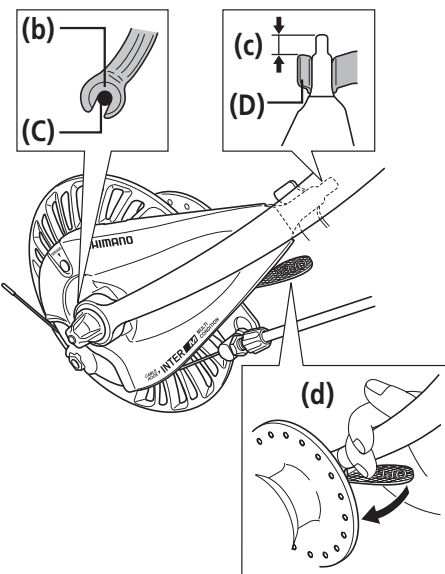

Check that the hub axle (C) is touching the back of the dropout, and that the end of the brake arm is protruding 11 mm or more from the brazed-on bracket (D) of the front fork. Check also that the wheel is firmly secured to the frame with the quick release or the hub nut.

If the wheel is not installed properly, it may come off the frame, which could result in a serious accident when riding.

(b) Touching
(c) 11 mm or more
(d) For quick release type:
Secure the cam lever of the quick release firmly.

- (C) Hub axle
- (D) Brazed-on bracket

Cam lever tightening torque	
5 - 7.5 N·m	

<For nut type>

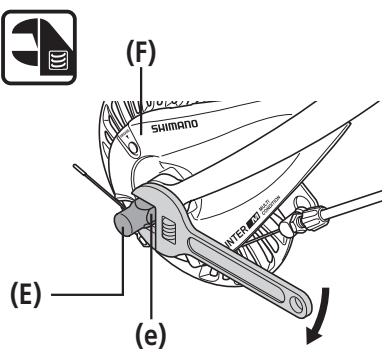

Check that the front brake unit (F) is firmly secured to the hub body with the hub nut (E).

(e) Without notches

- (E) Hub nut
- (F) Brake unit

Tightening torque	
	20 - 25 N·m

■ Installation of the brake cable

Rear side

1

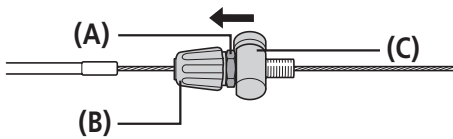

After checking that the cable adjustment barrel (B) and adjustment nut (A) are fully tightened, insert the outer holder unit (C) into the inner cable in the direction shown in the illustration.

- (A) Adjustment nut
- (B) Cable adjustment barrel
- (C) Outer holder unit

2

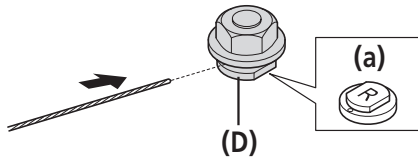

After checking that the marking of the back side of the inner cable fixing bolt unit (D) is "R", pass the inner cable through the hole of the inner cable fixing bolt unit.

(a) "R" marking

- (D) Inner cable fixing bolt unit

3

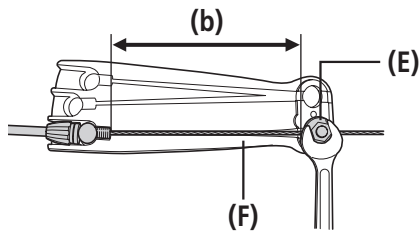

Place the components as shown in the following figure and tighten the inner cable fixing nut (E).

Use (b) 99 mm of TL-IM21 (F) to tighten the inner mounting nut as shown in the illustration.

- (E) Inner cable fixing nut
- (F) TL-IM21

Tightening torque



6 - 8 N·m

NOTICE

- After tightening, check that the orientations of the inner cable fixing nut and inner cable are correct as shown in the illustration.



- Never tighten the inner cable fixing bolt with it attached to brake. The orientations of the inner cable fixing nut and inner cable will become improper as shown in the illustration, which may cause the inner cable fixing bolt to detach from the brake body.

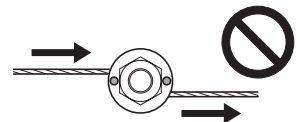

4

Align the red mark on the inner cable fixing washer (H) so that it faces in the direction of the groove in the winder unit (G), and then insert the inner cable fixing bolt unit (I) and push it into the groove in the winder unit as far as it will go.

(c) Insert the inner cable fixing bolt unit and push it into the groove in the winder unit as far as it will go.

- (G) Groove in the winder unit
- (H) Red mark on inner cable fixing washer
- (I) Inner cable fixing bolt unit

5

Route the inner cable (J) along the groove in the winder unit (K).

- (J) Inner cable
- (K) Groove in the winder unit

6

Insert the outer holder unit (M) into the hole of the brake arm (L) from underneath and slide it to the lower section of the hole.

- (L) Brake arm
- (M) Outer holder unit

7

After checking that the outer holder unit (O) is inserted as far as it will go into the brake arm hole, install the inner end cap (N).

Then, set the inner end cap so that it does not touch the fin or the spokes.

- (N) Inner end cap
- (O) Outer holder unit

8

Turn the cable adjustment barrel (P) to tighten the inner cable.

- (P) Cable adjustment barrel

INSTALLATION

► Installation of the brake cable

9

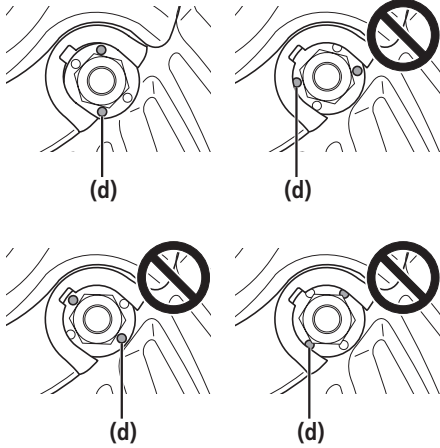

After pressing the lever, check that the red marks on the inner cable fixing washer with the inner cable mounting bolt unit press-fit into the winder unit are in the right direction as shown in the illustration.

(d) Red



TECH TIPS

When detaching the cable, perform in reverse order.

Front side

1

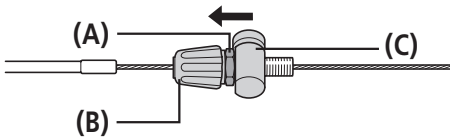

After checking that the cable adjustment barrel (B) and adjustment nut (A) are fully tightened, insert the outer holder unit (C) into the inner cable in the direction shown in the illustration.

- (A) Adjustment nut
- (B) Cable adjustment barrel
- (C) Outer holder unit

2

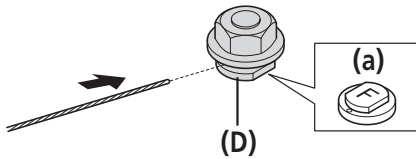

After checking that the marking of the back side of the inner cable fixing bolt unit (D) is "F", pass the inner cable through the hole of the inner cable fixing bolt unit.

(a) Markings "F"

- (D) Inner cable fixing bolt unit

INSTALLATION

► Installation of the brake cable

3

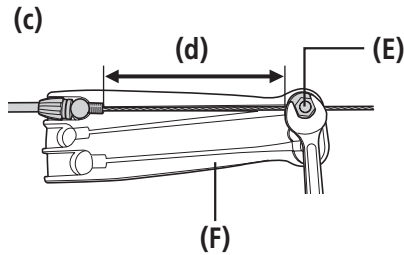
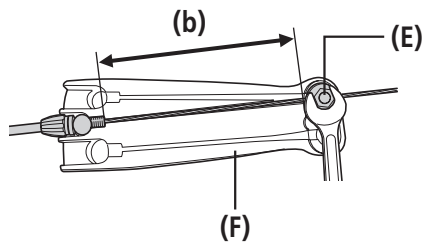

Place the components as shown in the following figure and tighten the inner cable fixing nut (E).

Use (b) 109 mm of TL-IM21 (F) to tighten the inner mounting nut as shown in the illustration.
Use (d) 101 mm for BR-IM86.

(E) Inner cable fixing nut

(F) TL-IM21

Tightening torque



6 - 8 N·m

NOTICE

- After tightening, check that the orientations of the inner cable fixing nut and inner cable are correct as shown in the illustration.

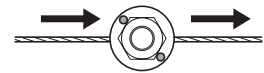

- Never tighten the inner cable fixing bolt with it attached to brake. The orientations of the inner cable fixing nut and inner cable will become improper as shown in the illustration, which may cause the inner cable fixing bolt to detach from the brake body.

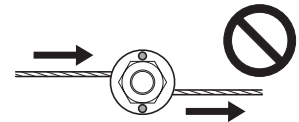

4

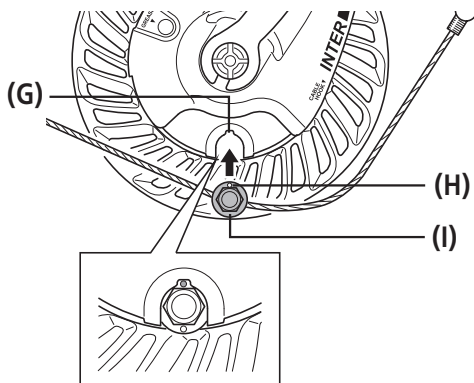

Align the red mark on the inner cable fixing washer (H) so that it faces in the direction of the groove in the winder unit (G), and then insert the inner cable fixing bolt unit (I) and push it into the groove in the winder unit as far as it will go.

(G) Groove in the winder unit

(H) Red mark on inner cable fixing washer

(I) Inner cable fixing bolt unit

5

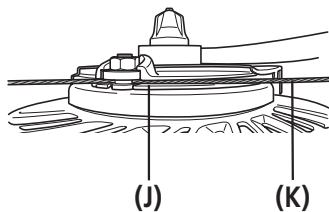

Route the inner cable (K) along the groove in the winder unit (J).

(J) Groove in the winder unit

(K) Inner cable

INSTALLATION

▶ Installation of the brake cable

6

Hook the inner cable (M) over the cable hook (L).

- (L) Cable hook
- (M) Inner cable

7

Insert the outer holder unit (O) into the hole of the brake arm (N) from underneath and slide it to the lower section of the hole.

- (N) Brake arm
- (O) Outer holder unit

8

After checking that the outer holder unit (Q) is inserted as far as it will go into the guide slot in the brake arm, install the inner end cap (P).

Then, set the inner end cap so that it does not touch the fin or the spokes.

- (P) Inner end cap
- (Q) Outer holder unit

9

Turn the cable adjustment barrel (R) to tighten the inner cable.

- (R) Cable adjustment barrel

10

After pressing the lever, check that the red marks on the inner cable fixing washer with the inner cable mounting bolt unit press-fit into the winder unit are in the right direction as shown in the illustration.

(e) Red



TECH TIPS

Installation of the brake cable can be completed by the above procedure. When detaching the cable, perform in reverse order.

INSTALLATION

► Installation of the brake cable

<For BR-IM31/35>

1

Place the cable adjustment barrel (A) so that it is (a) 13 to 15 mm from the end of the outer casing holder (B), and then pass the inner cable through the cable adjustment barrel and then through the hole (C) in the inner mounting bolt.

- (A) Cable adjustment barrel
- (B) Outer casing holder
- (C) Hole in the inner cable fixing bolt

2

Check that both ends (b) of the outer casing are securely inserted into the cable adjustment barrels (D) of both the brake lever and brake arm.

- (D) Cable adjustment barrel

3

Push the link back until it stops. Then, while pulling the inner cable to apply the full amount of tension to the cable, tighten the inner cable fixing nut (E).

- (E) Inner cable fixing nut

Tightening torque	
	6 - 8 N·m

NOTICE

The inner cable has to be set so that it passes under the link, as shown in the illustration (c).

ADJUSTMENT

ADJUSTMENT

■ Adjusting the brake cable

Rear side

1

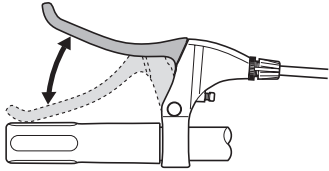

After checking that the wheel does not easily turn while the brake cable is being pulled, depress the brake lever about 10 times as far as the grip in order to run in the brake cable.

NOTICE

If the brake cable is not run in, it will need to be adjusted again after only a short period of use.

2

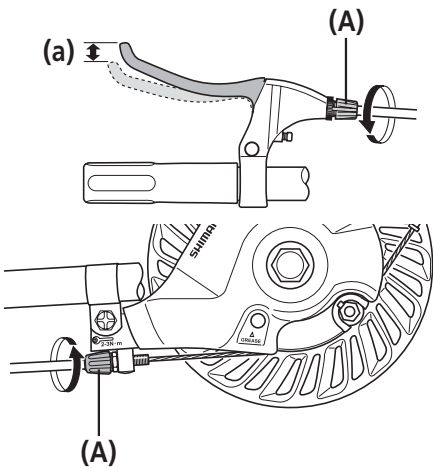

Turn the cable adjustment barrel (A) of the brake unit or brake lever so that there is a 15 mm gap (a) (11 mm for BL-C6010) in the brake lever.

(The amount of brake lever gap is the distance from the position where the brake lever is not operated to the position where a force is felt suddenly when the brake lever is pulled.)

(A) Cable adjustment barrel

3

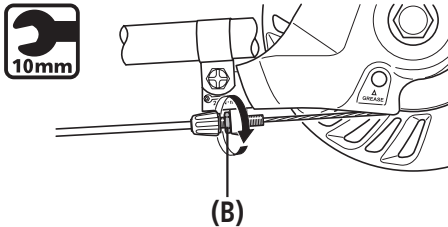

After depressing the brake lever to check the braking performance, secure the cable adjustment barrel with the cable adjustment nut (B).

(B) Cable adjustment nut

Tightening torque



1 - 2 N·m

ADJUSTMENT

▶▶ Adjusting the brake cable

Front side

1

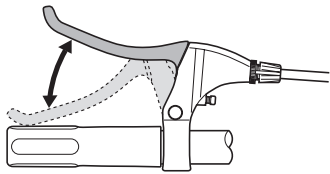

After checking that the wheel does not easily turn while the brake cable is being pulled, depress the brake lever about 10 times as far as the grip in order to run in the brake cable.

NOTICE

If the brake cable is not run in, it will need to be adjusted again after only a short period of use.

2

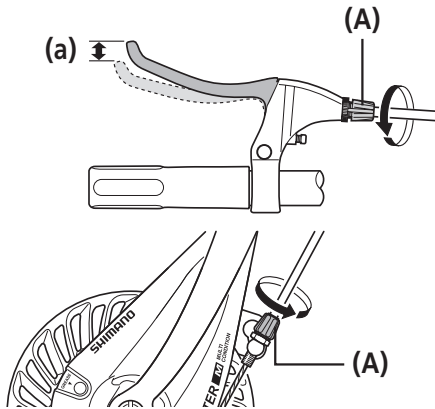

Turn the cable adjustment barrel (A) of the brake unit or brake lever so that there is a 15 mm gap (a) (11 mm for BL-C6010) in the brake lever.

(The amount of brake lever gap is the distance from the position where the brake lever is not operated to the position where a force is felt suddenly when the brake lever is pulled.)

(A) Cable adjustment barrel

3

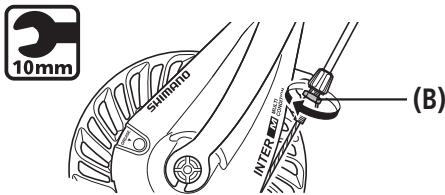

After depressing the brake lever to check the braking performance, secure the cable adjustment barrel with the cable adjustment nut (B).

(B) Cable adjustment nut

Tightening torque



1 - 2 N·m

MAINTENANCE

MAINTENANCE

■ Applying grease

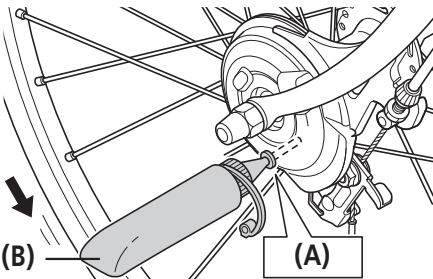
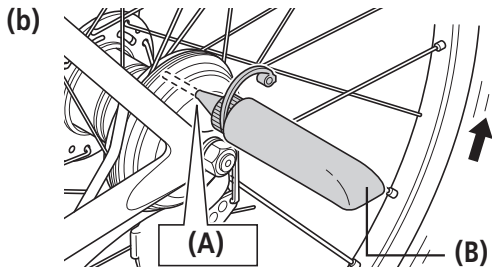
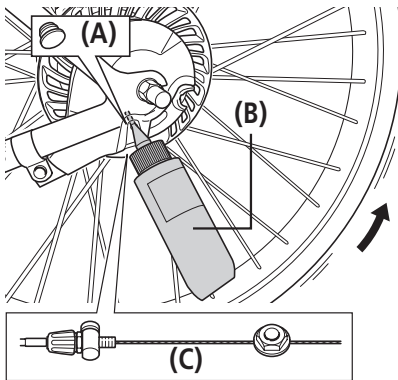
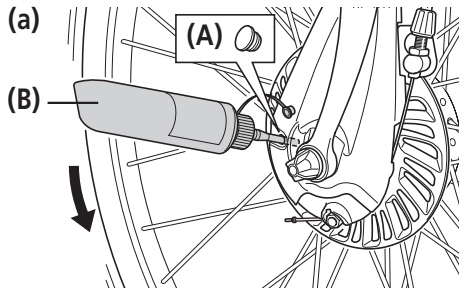

Before applying grease for roller brakes (B), remove the grease hole cap (A) and press-fit the tube into the back of the hole 12 mm or more. Apply an appropriate amount of grease (approx. 5 g) while turning the wheel slowly.

After application, check that braking is properly applied and that no abnormal noise is heard.

(a) For BR-C6060-F/C6000/C3000/C3010

(b) For BR-IM31/35

(A) Grease hole cap

(B) Grease for roller brakes

(C) Cable unit

SHIMANO

SHIMANO NORTH AMERICA BICYCLE, INC.

One Holland, Irvine, California 92618, U.S.A. Phone: +1-949-951-5003

SHIMANO EUROPE B.V.

High Tech Campus 92, 5656 AG Eindhoven, The Netherlands Phone: +31-402-612222

SHIMANO INC.

3-77 Oimatsu-cho, Sakai-ku, Sakai City, Osaka 590-8577, Japan

Please note: specifications are subject to change for improvement without notice. (English)

© Dec. 2019 by SHIMANO INC. ITP